

Faculty of Dentistry - University of Hong Kong

Removable partial denture design

- a reference guide

J.E.Dyson

Oral **R**ehabilitation

1997-98

UNIVERSITY OF HONG KONG
LIBRARY



*This book was a gift
from*

Faculty of Dentistry

Contents

Overview of treatment planning and design.....	1
The preliminary (“ideal”) design	2
Surveying procedure.....	7
Lecture handout 1 (Introduction to the principles of RPDs)	9
Lecture handout 2 (Components of RPDs and preliminary design).....	14

Removable partial denture design

- a reference guide

JE Dyson - 2 December, 1997

Overview of treatment planning and removable partial denture design for patients requiring extractions or with missing teeth.

1. Control disease (OHI, scaling, dietary control, stabilization of cavities, fluoride applications *etc.* as required)
2. Determine prognosis and future treatment of all remaining teeth.
3. Decide which teeth need to be replaced by the denture.
4. Make a preliminary design (Refer only to the saddle distribution)
5. Select a path of insertion (Refer to:-
 - soft tissue undercuts
 - guiding planes
 - dead spaces
 - retentive undercuts)
6. Mark out all undercut areas (Teeth and soft tissues)
7. Mark guiding planes (Blue pencil)
8. Mark retentive undercuts (Red pencil)
9. Mark base of cast and/or indicate tripod points.
10. Plan tooth preparation (including restorations for abutment teeth) (Refer to:-
 - survey lines
 - occlusion)
11. Modify the preliminary design and redraw (Refer to results of :-
 - clinical examination
 - radiographic examination
 - analysis of study casts)
12. Finalize the treatment plan
13. Carry out all other restorative treatment before constructing dentures

The preliminary (“ideal”) design

1. Decide which teeth need to be replaced and outline the saddles.
2. Connect the saddles.
3. Prevent movement -
 - towards the tissues (support - rests)
 - away from the tissues (retention - clasps)
 - antero-posteriorly (proximal plates, mesial-distal grips etc.)
 - laterally (bracing components)
4. Prevent rotations.
5. Simplify the design and review aesthetics.

Example:

1. Decide which teeth need to be replaced and outline the saddles.

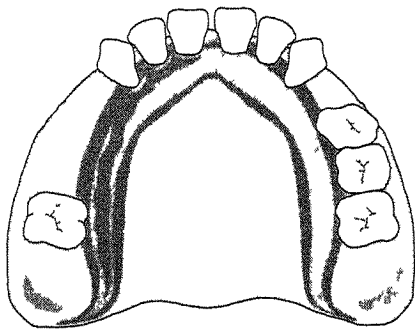

The missing third molars do not need to be replaced and are therefore ignored

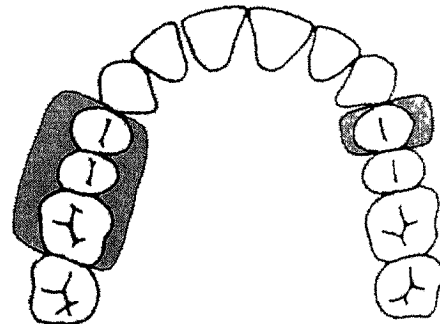

2. Connect the saddles.

Connect the saddles using an appropriate (simplest) type of major connector

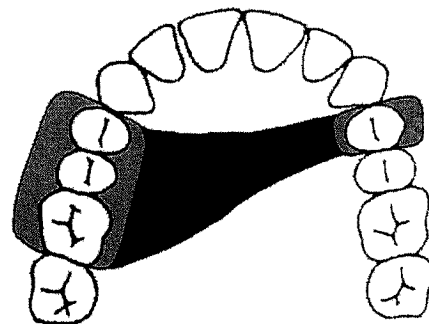

3. Prevent movement towards the tissues

(support – rests)

Add rests on the teeth adjacent to the saddles

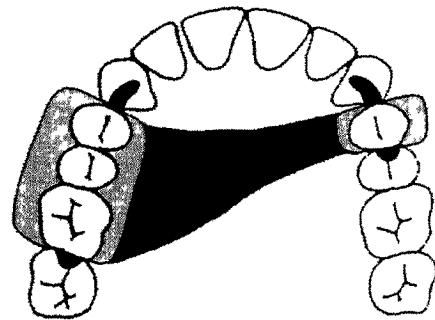

4. Prevent movements away from the tissues

(retention – clasps)

Add clasp arms and reciprocal arms to the teeth adjacent to the saddles. (Avoid placing clasps on anterior teeth unless these are distal abutments for free-end saddles).

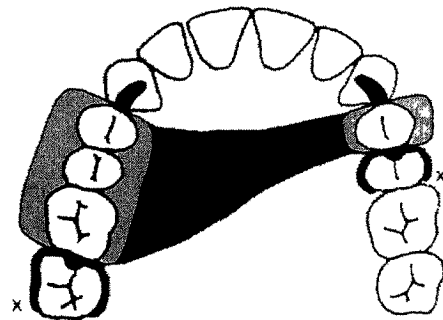

5. Prevent movements antero-posteriorly

Anterior movement is already resisted by contact of the saddles with the distal surfaces of 13 and 23. Posterior movement is similarly resisted by contacts with the mesial surfaces of 17 and 25. No additional components therefore need to be added

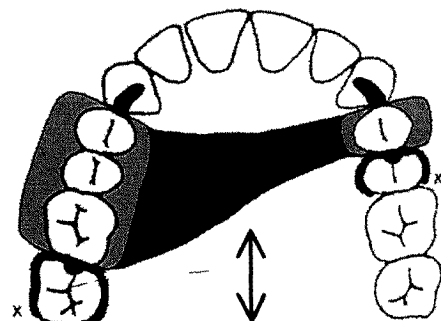

6. Prevent movements laterally

Movement to the patient's right is already resisted by contact of the cingulum rest with 13 and the reciprocal arm with the palatal surface of 17. Movement to the left is similarly resisted by contact of the cingulum rest with 23 and the reciprocal arm with 25. No additional components therefore need to be added

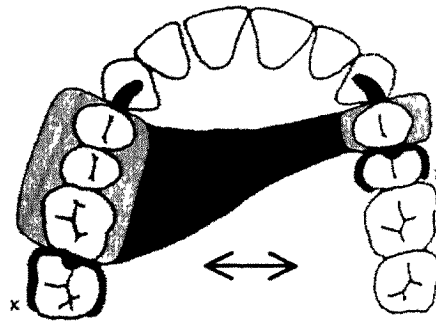

7. Prevent rotations

Axis A-B

Rotation about the axis A-B would cause the saddle on the left (replacing 24) to move away from or towards the tissues. However, movement towards the tissues is already resisted by the rests on the adjacent abutments. The clasp on 25 prevents movement away from the tissues.

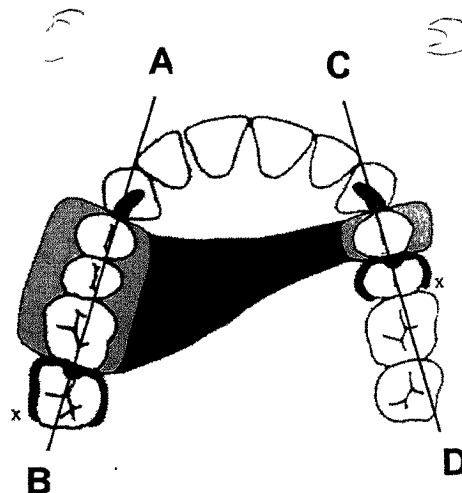

Axis C-D

Rotation about this axis is similarly resisted by the rests on 13 and 17 and by the clasp on 17.

Axis E-F

Rotation about the axis E-F is resisted by the rests and clasps on 17 and 15.

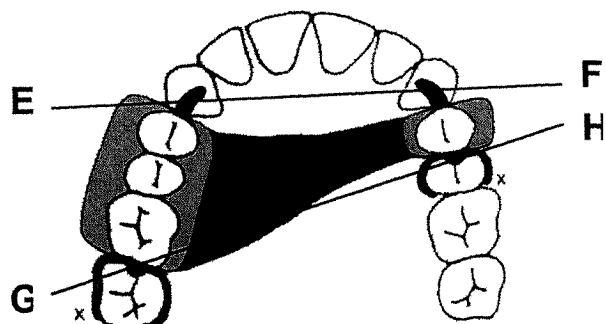

Axis G-H

When rotation tends to occur about the axis G-H, movement of the anterior part of the denture towards the tissues is resisted by the rests on 13 and 23. Movement of this part of the denture away from the tissues is, however, not resisted as clasps are not present on the canines (these were omitted for aesthetic reasons).

Rotation of the anterior part of the denture away from the tissues could be prevented by placing a rest on a tooth posterior to the axis G-H (thus providing **indirect retention**). A clasp may be usefully incorporated with the rest to improve retention.

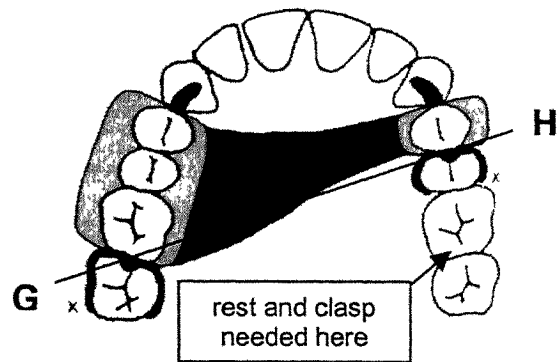

Extension of the major connector is needed to join the rest/clasp assembly on 26 to the rest of the denture. Rotations in both directions about the axis G-H are now resisted.

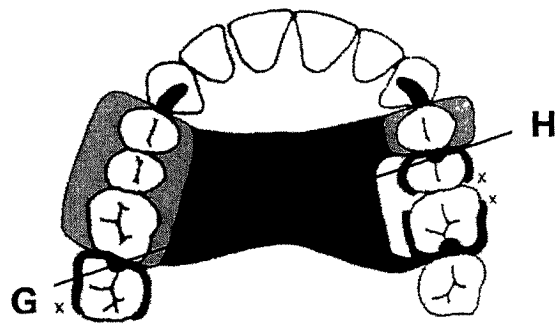

简化
8. Simplify the design and review aesthetics

The design is reviewed with a view to eliminating any unnecessary components and modifying unsightly elements. In this case all the components are probably needed but the distally directed clasp on 24 would be unsightly. This can be replaced by a gingivally approaching clasp to improve the appearance.

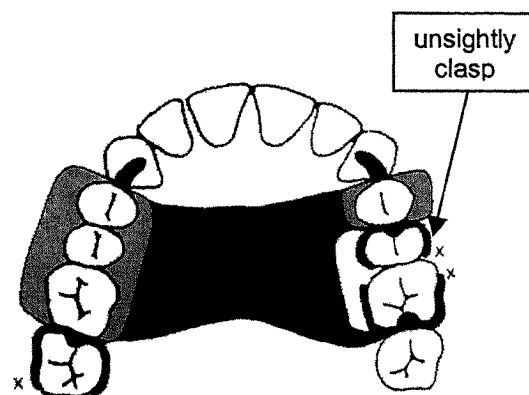

8. Redraw the completed preliminary design

As the design is further developed it may require modification to take into account the location of undercuts etc.

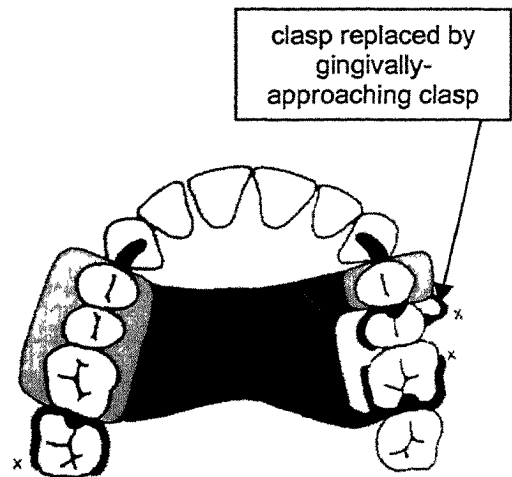

Other modifications may also be introduced to improve the design (e.g. the clasp on 17 might be improved by placing a rest on the distal side of this tooth and changing the direction of the circumferential clasp to approach the mesial undercut from the distal part of the tooth).

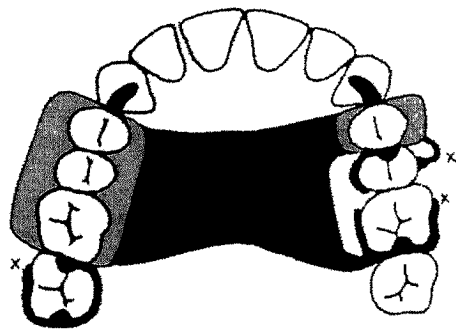

Surveying Procedure

1. Attach the cast firmly to surveyor with its base flat on the surveyor table and the occlusal plane horizontal.
2. With the analysing rod examine for the presence of undercuts in the edentulous areas and adjust the cast tilt to minimise dead space.
4. Examine the tooth contours with the analysing rod and adjust the tilt to achieve as many guiding planes as possible on the proximal surfaces of the abutment teeth and in the regions where clasp reciprocation is need.
(Exceptions: For free-end saddle designs where RPI or RPA clasp assemblies are to be used, the cast should be tilted so that undercuts are present on the distal surfaces of the distal abutments. Special considerations may also apply for Kennedy class IV designs).
4. Modify the cast tilt to even out (or localize) the dead spaces and to equalise the retentive undercuts.
5. Check again at the new tilt that guiding planes are still available and lightly mark them with a blue pencil run along the analysing rod.
6. Change the analysing rod for sharply bevelled carbon marker and plot out all undercut zones on both hard and soft tissue.
EACH UNDERCUT MUST BE MARKED WITH BOTH AN UPPER AND A LOWER SURVEY LINE.
7. Select the appropriate undercut gauge (0.25 mm for most cobalt-chromium clasps) and identify suitable positions for the retentive tips of the clasps. Lightly mark each position with a small red dot.

8. Clearly indicate the orientation of the cast by marking three or more tripod points (on the cusp tips if possible) and/or mark the base of the cast with three widely spaced vertical lines drawn by running a pencil along the analysing rod.
9. Examine the casts in the articulator with respect to the space available for the denture components that might interfere with the patient's occlusion.
10. Carefully note all tooth preparation procedures which will be necessary to:-
 - avoid occlusal interferences.
 - improve the guiding planes.
 - minimise the dead spaces.
 - improve or create retentive undercuts.
11. Redraw the modified denture design indicating the tagging for retention of the acrylic saddles.

This final design should be neatly drawn on the 'tooth preparation form' and on the back of the dental chart on the patient's hospital records. Only after the master cast has been resurveyed should the design be drawn on the laboratory card.

Oral **R**ehabilitation

Introduction to the principles of

removable partial dentures

JE Dyson - October 1997

reasons for tooth loss

- periodontal disease
- caries
- trauma
- failed restoration

2

consequences of tooth loss

- bone resorption (remodelling)
- loss of support of facial soft tissues
- loss of appearance
- loss of function (mastication, speech)
- overeruption, tilting and drifting of the remaining teeth
- effects on occlusion and jaw relationships

3

reasons for replacing missing teeth

- restoration of appearance
- restoration of function
 - speech
 - mastication
- maintenance or restoration of occlusal stability

4

alternative methods of managing patients with missing teeth

- masterly inactivity
- provide fixed prosthesis
 - conventional bridge
 - resin-bonded bridge
- provide implant supported prosthesis
- provide removable partial denture

5

potential harmful effects of partial dentures

- promote caries
- promote periodontal disease
- promote resorption of alveolar bone
- induce mucosal pathology

6

minimizing the potential harmful effects of partial dentures

- achieve improved oral hygiene
- replace only those teeth which need to be replaced
- minimal coverage of teeth and gingivae
- good design (good support and stability)

7

features required of the denture

- support
- retention
- stability

8

denture retention

- resistance of a denture to vertical movement away from the tissues

9

denture support

- resistance of a denture to occlusally-directed loads

10

denture stability

- resistance of a denture to displacement by functional loads

resistance to: lateral movement
antero-posterior movement

11

situations in which a removable partial denture may be preferred above other prostheses

- long edentulous spans
- lost alveolar bone/soft tissue needs to be replaced
- patient preference
- where extensive tooth preparation/surgery is contraindicated
- time/cost constraints

12

components of removable partial dentures

- saddles
- connectors
- rests
- clasps (*retainers*)
- bracing components

13

classification of saddles

- bounded or free-end (distal extension)
- flanged or flangeless

14

classification of removable partial dentures

- by support
 - mucosal borne
 - tooth borne
 - tooth/mucosal borne
- by saddle distribution (Kennedy classification)
 - Kennedy class I, II, III, IV

15

classification of removable partial dentures

by support

1) tooth borne

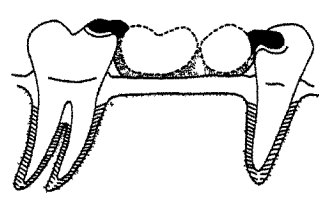

16

classification of removable partial dentures

by support

2) mucosal borne

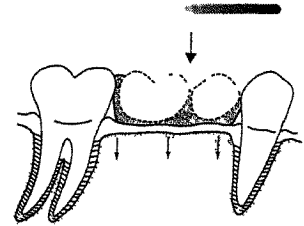

17

classification of removable partial dentures

by support

3) tooth/mucosal borne

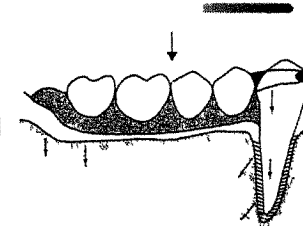

18

classification of removable partial dentures

Kennedy classification - principles of the system

- ignore teeth not to be replaced
- most posterior saddle determines the class
 - additional saddles are "modifications"
- class IV must cross the midline

19

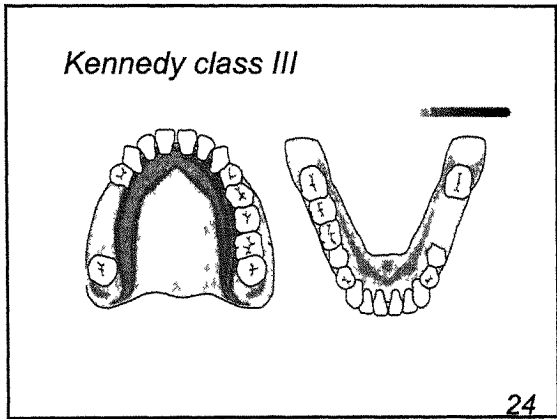
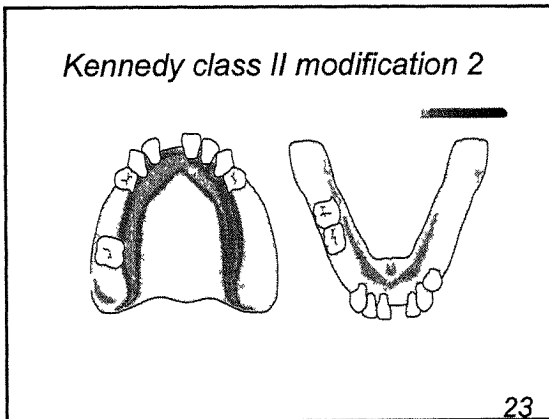
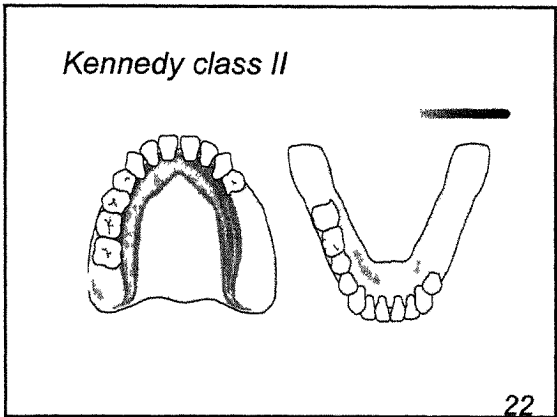
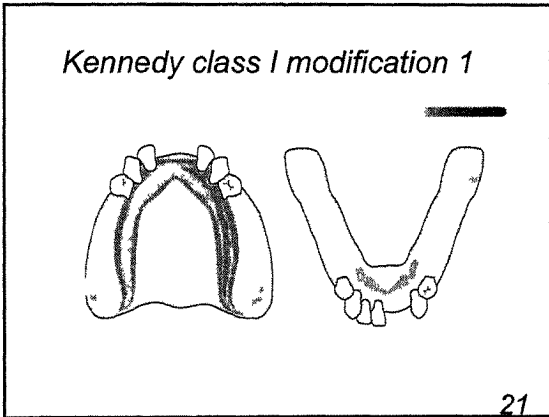
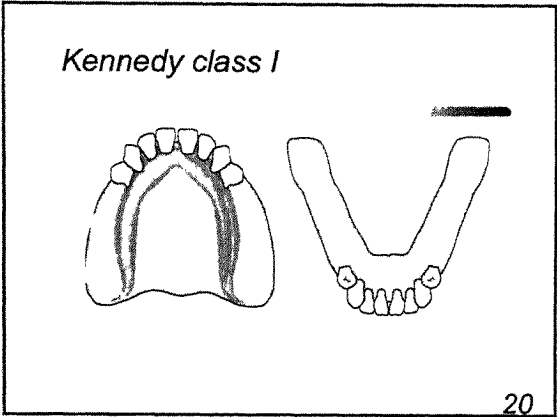

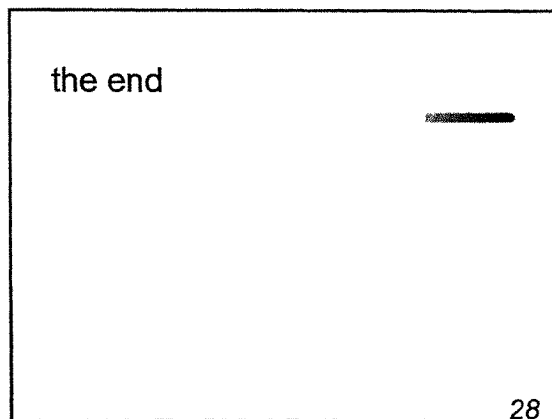
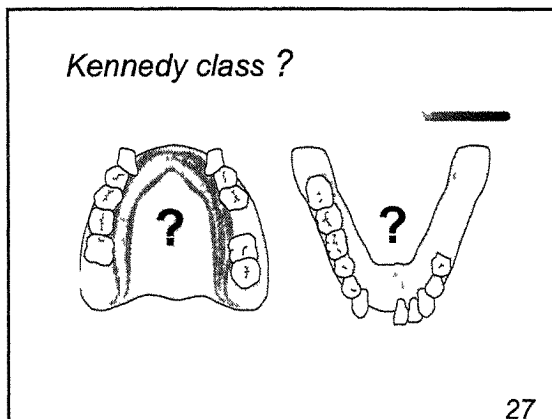
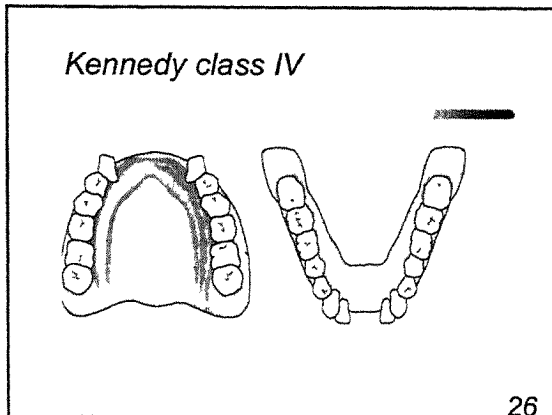
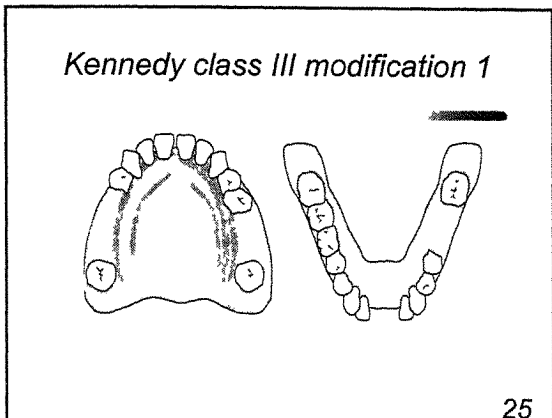

O_{ral}**R**_{ehabilitation}

components of removable partial dentures

and preliminary design

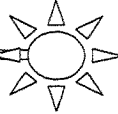

JE Dyson - October 1997

1

features required of the denture



- support → rests
- retention → clasps, indirect retainers
- stability → bracing components

2

components of removable partial dentures





- saddles
- connectors
- rests
- clasps (*retainers*)
- bracing components

3

saddles



- flangeless 
- flanged 

4

connectors



- major
 - connect saddles together
- minor
 - connect components to the major connector

5

major connectors - bar vs. plate

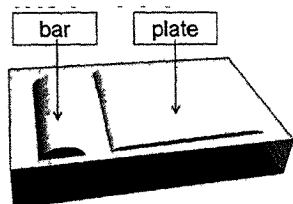
6

connectors

must be rigid

7

maxillary major connectors

Diagram illustrating maxillary major connectors on a maxillary dental arch. The arch is divided into three regions: anterior, mid, and posterior. A bracket on the right side groups these three regions under the label 'palatal', with sub-labels 'bar' and 'plate' pointing to the respective connector types.

8

maxillary major connectors

- anterior palatal bar/plate
- mid palatal bar/plate
- posterior palatal bar/plate
- palatal plate

9

mandibular major connectors

- lingual bar
- lingual plate
- sublingual bar
- dental bar
- buccal bar

10

mandibular major connectors

Diagram illustrating a lingual bar connector on a mandibular dental arch. A callout box indicates '3 mm space for gingival clearance' between the bar and the gingiva. Another callout box indicates '4 mm for lingual bar' for the height of the bar.

lingual bar

11

mandibular major connectors

Diagram illustrating a lingual plate connector on a mandibular dental arch, showing the plate covering the lingual surfaces of the teeth.

lingual plate

12

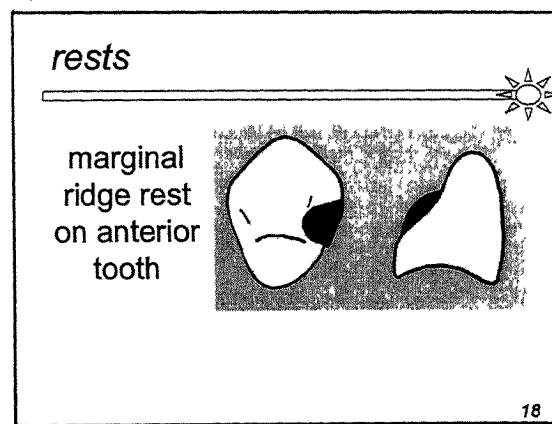
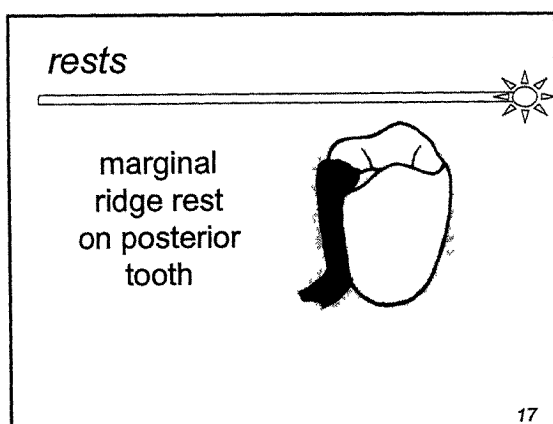
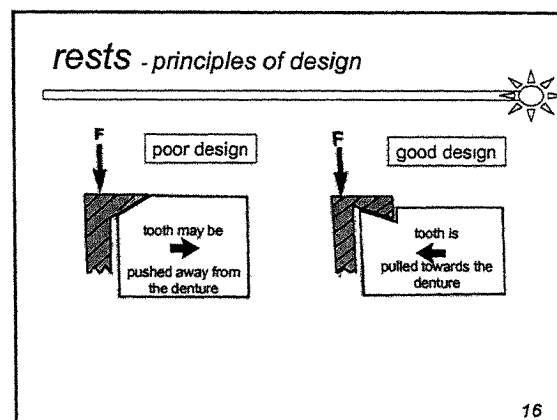
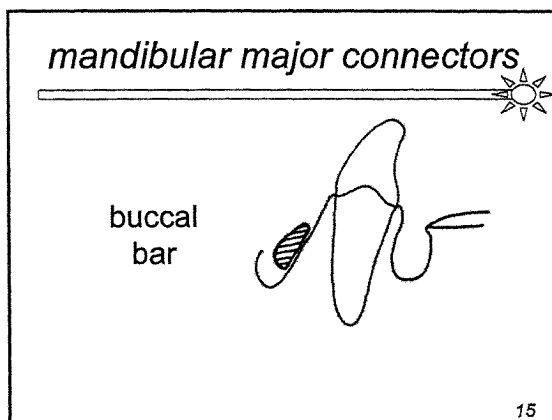
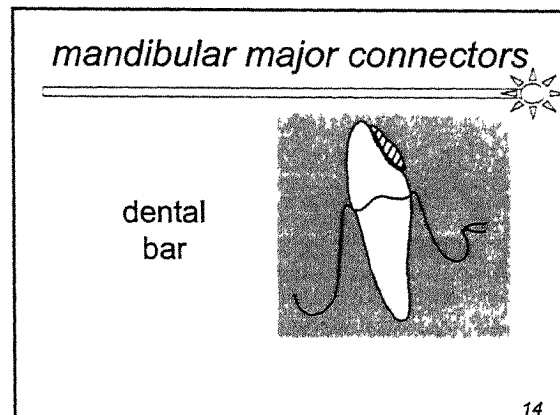
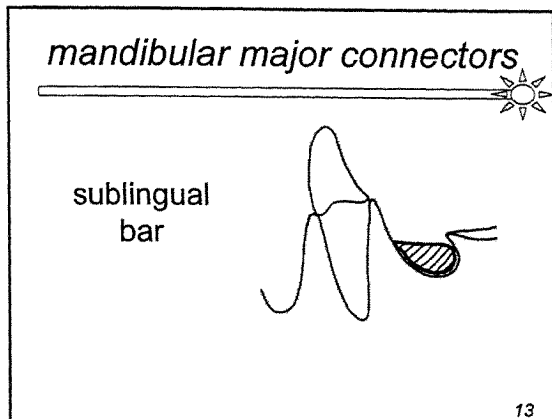

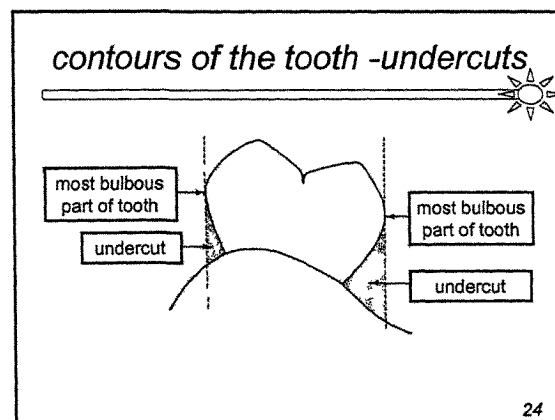
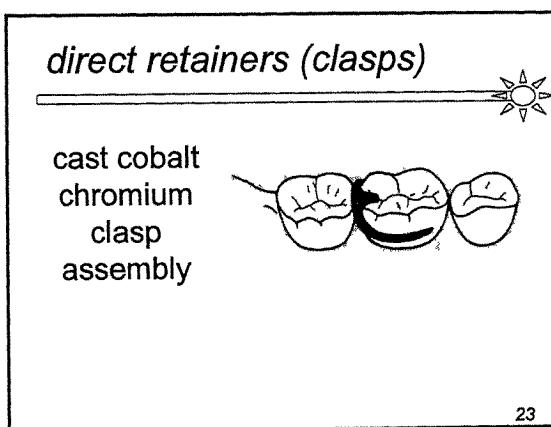
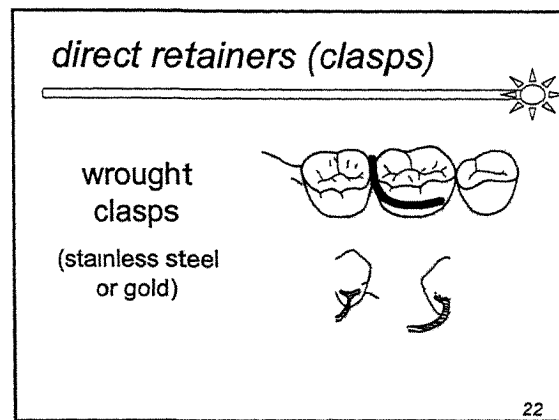
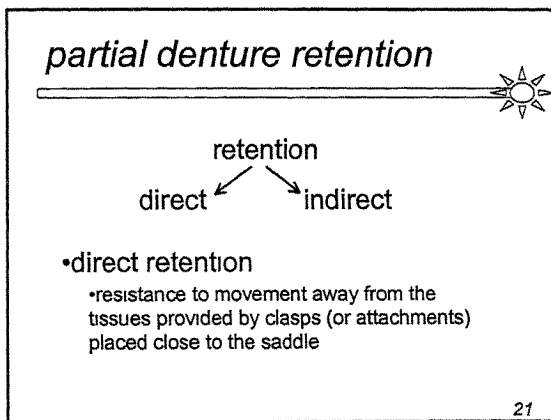
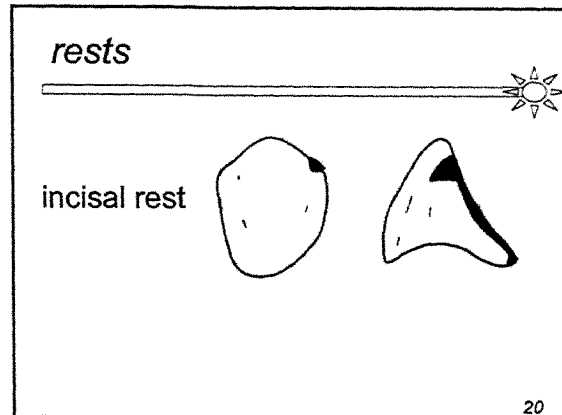
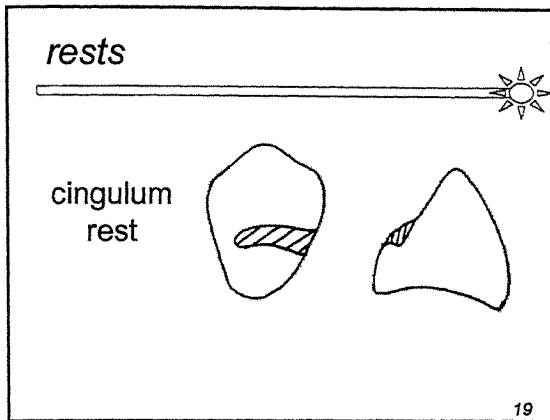

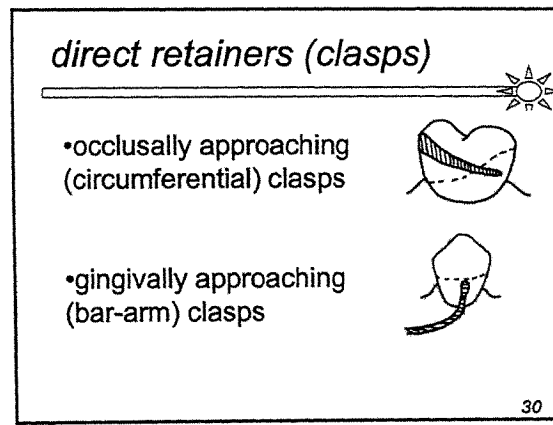
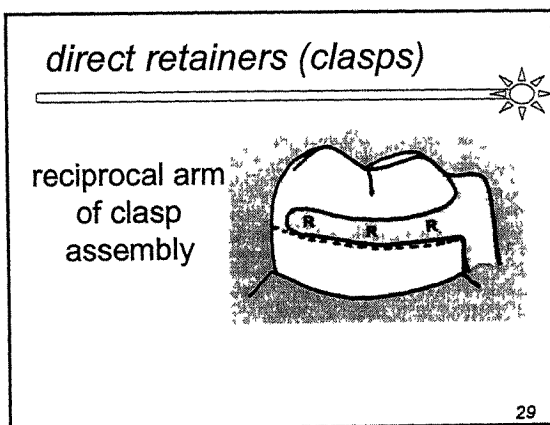
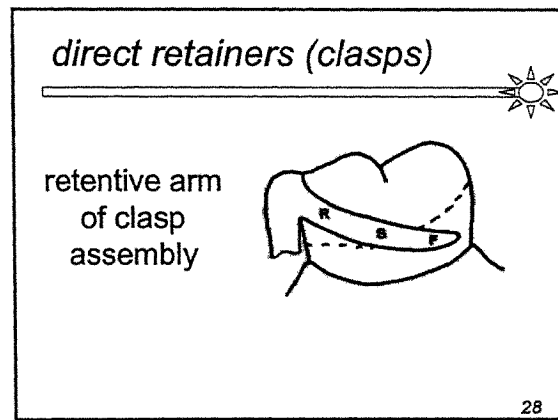
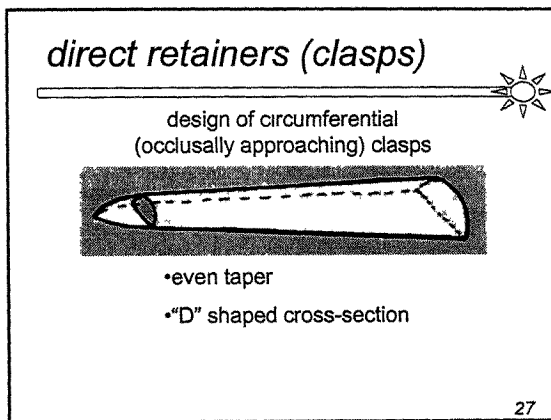
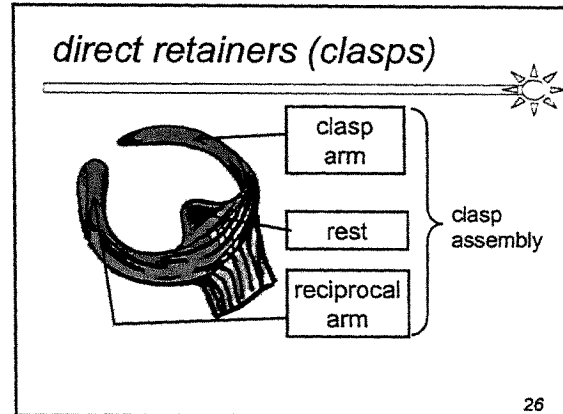
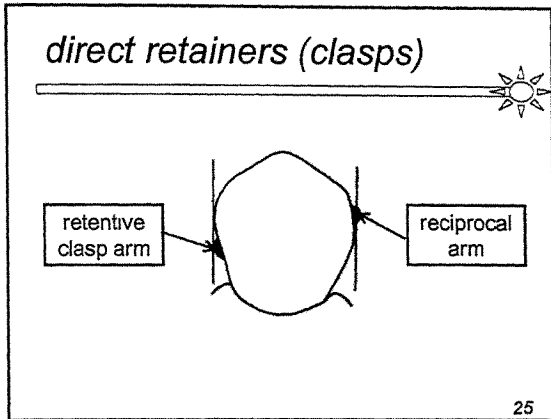

direct retainers (clasps)

types of gingivally approaching (bar-arm) clasps

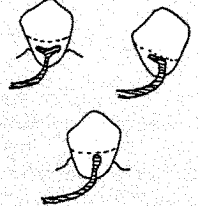

31

mechanical features of a correctly designed clasp

the clasp should:

- provide retention
- be passive
- be reciprocated
- be supported
- be braced
- encircle the tooth by more than 180°

32

encirclement

tooth can move away from clasp

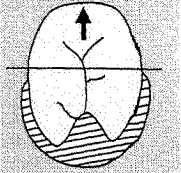

correctly designed clasp

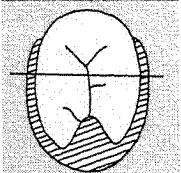

33

partial denture retention

retention

direct ← → indirect

- indirect retention
 - resistance to movement away from the tissues provided by supporting components placed distant to the saddle on the opposite side of the potential axis of rotation

34

indirect retention

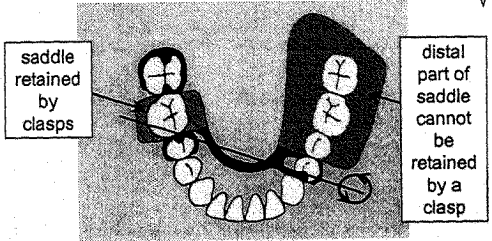

saddle retained by clasps

distal part of saddle cannot be retained by a clasp

35

indirect retention

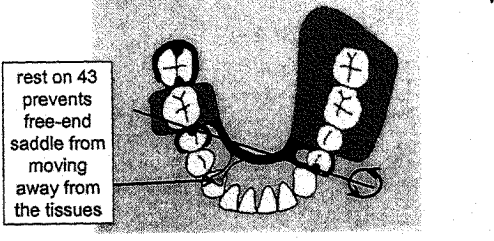

rest on 43 prevents free-end saddle from moving away from the tissues

36

bracing components

- rigid parts of clasps
- minor connectors
- mesial-distal grips

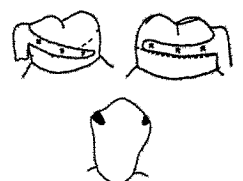

37

preliminary ("ideal") design

- 1) decide which teeth need to be replaced and outline the saddles

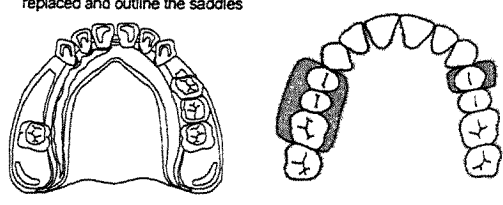

38

preliminary ("ideal") design

- 1) decide which teeth need to be replaced and outline the saddles
- 2) connect the saddles

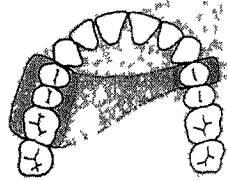

39

preliminary ("ideal") design

- 1) decide which teeth need to be replaced and outline the saddles
- 2) connect the saddles
- 3) prevent movement:
 - a) towards the tissues

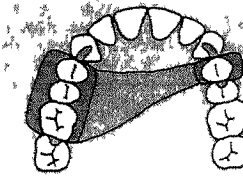

40

preliminary ("ideal") design

- 1) decide which teeth need to be replaced and outline the saddles
- 2) connect the saddles
- 3) prevent movement
 - a) towards the tissues
 - b) away from the tissues

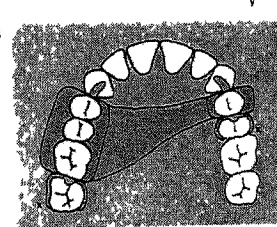

41

preliminary ("ideal") design

- 1) decide which teeth need to be replaced and outline the saddles
- 2) connect the saddles
- 3) prevent movement
 - a) towards the tissues
 - b) away from the tissues
 - c) antero-posteriorly

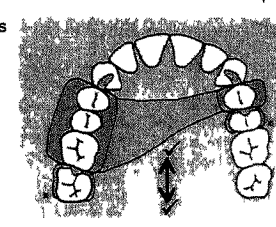

42

preliminary ("ideal") design

- 1) decide which teeth need to be replaced and outline the saddles
- 2) connect the saddles
- 3) prevent movement
 - a) towards the tissues
 - b) away from the tissues
 - c) antero-posteriorly
 - d) laterally

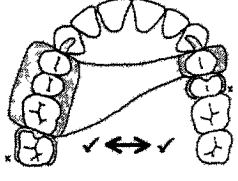

43

preliminary ("ideal") design

- 1) decide which teeth need to be replaced and outline the saddles
- 2) connect the saddles
- 3) prevent movement
 - a) towards the tissues
 - b) away from the tissues
 - c) antero-posteriorly
 - d) laterally
- 4) prevent rotations

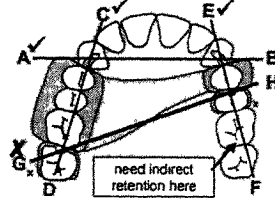

44

preliminary ("ideal") design

- 1) decide which teeth need to be replaced and outline the saddles
- 2) connect the saddles
- 3) prevent movement
 - a) towards the tissues
 - b) away from the tissues
 - c) antero-posteriorly
 - d) laterally
- 4) prevent rotations

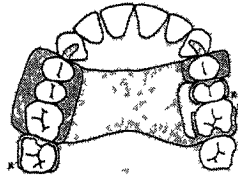

45

preliminary ("ideal") design

- 1) decide which teeth need to be replaced and outline the saddles
- 2) connect the saddles
- 3) prevent movement
 - a) towards the tissues
 - b) away from the tissues
 - c) antero-posteriorly
 - d) laterally
- 4) prevent rotations
- 5) **simplify the design and review aesthetics**

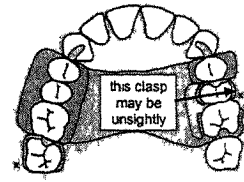

46

preliminary ("ideal") design

- 1) decide which teeth need to be replaced and outline the saddles
- 2) connect the saddles
- 3) prevent movement
 - a) towards the tissues
 - b) away from the tissues
 - c) antero-posteriorly
 - d) laterally
- 4) prevent rotations
- 5) **simplify the design and review aesthetics**

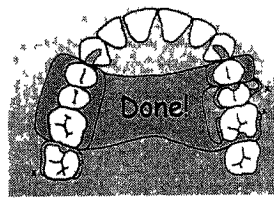

47

the end

48

X10692650

