

# ATM-Based TH-SSMA Network for Multimedia PCS

Moe Z. Win, *Senior Member, IEEE*, Xiaoxin Qiu, *Member, IEEE*,  
Robert A. Scholtz, *Fellow, IEEE*, and Victor O. K. Li, *Fellow, IEEE*

**Abstract**—Personal communications services (PCS) promise to provide a variety of information exchanges among users with any type of mobility, at any time, in any place, through any available device. To achieve this ambitious goal, two of the major challenges in the system design are: i) to provide a high-speed wireless subsystem with large capacity and acceptable quality-of-service (QoS) and ii) to design a network architecture capable of supporting multimedia traffic and various kinds of user mobility. A time-hopping spread-spectrum wireless communication system called ultra-wide bandwidth (UWB) radio is used to provide communications that are low power, high data rate, fade resistant, and relatively shadow free in a dense multipath environment. Receiver-signal processing of UWB radio is described, and performance of such communications systems, in terms of multiple-access capability, is estimated under ideal multiple-access channel conditions. A UWB-signal propagation experiment is performed using the bandwidth in excess of 1 GHz in a typical modern office building in order to characterize the UWB-signal propagation channel. The experimental results demonstrate the feasibility of the UWB radio and its robustness in a dense multipath environment. In this paper, an ATM network is used as the backbone network due to its high bandwidth, fast switching capability, flexibility, and well-developed infrastructure. To minimize the impact caused by user mobility on the system performance, a hierarchical network-control architecture is postulated. A wireless virtual circuit (WVC) concept is proposed to improve the transmission efficiency and simplify the network control in the wireless subsystem. The key advantage of this network architecture and WVC concept is that the handoff can be done locally most of the time, due to the localized behavior of PCS users.

**Index Terms**—ATM, broadband network, multimedia, multiple access, personal communications services (PCS), spread spectrum, time-hopping, UWB radio.

Manuscript received January 1997; revised January 1999. This paper was supported in part by the Joint Services Electronics Program under Contract F49620-94-0022, and in part by the Integrated Media Systems Center, a National Science Foundation Engineering Research Center, with additional support from the Annenberg Center for Communication at the University of Southern California and the California Trade and Commerce Agency. Parts of this paper were presented at the IEEE Network+ Interop Conference, Las Vegas, NV, May 1997.

M. Z. Win is with the Wireless Systems Research Department, Newman Springs Laboratory, AT&T Labs-Research, Red Bank, NJ 07701-7033 USA (e-mail: win@research.att.com).

X. Qiu is with the Broadband Wireless Systems Research Department, Newman Springs Laboratory, AT&T Labs-Research, Red Bank, NJ 07701-7033 USA (e-mail: xqiu@research.att.com).

R. A. Scholtz is with the Communication Sciences Institute, Department of Electrical Engineering-Systems, University of Southern California, Los Angeles, CA 90089-2565 USA (e-mail: scholtz@milly.usc.edu).

V. O. K. Li is with the Department of Electrical and Electronic Engineering and Versitech Ltd., the University of Hong Kong, Hong Kong (e-mail: vli@eee.hku.hk).

Publisher Item Identifier S 0733-8716(99)05218-X.

## I. INTRODUCTION

### A. Introduction to Combined Wired/Wireless Network

PERSONAL communications services (PCS) promise to provide a variety of information exchanges (e.g., video, image, voice, data service, etc.) among users with any type of mobility, at any time, in any place, through any available device [1]. The success of PCS relies on the efficient amalgamation of broadband network technology, advanced radio transmission technique, and the personal-communication concept. PCS is characterized by packet- or cell-based transport, bandwidth-on-demand, multimedia-traffic integration, seamless connection, and customized service to the unique need of a given user. It implies that the system should be able to support multimedia traffic transmission in harsh radio environments with acceptable quality-of-service (QoS) and also deal with frequent handoffs when the user is roaming, a new challenge to the system designer [2]–[4].

To achieve this ambitious goal, two of the major challenges in the system design are: i) to provide a high-speed wireless subsystem with large capacity and acceptable QoS and ii) to design a network architecture capable of supporting multimedia traffic and various kinds of user mobility. In this paper, a time-hopping spread-spectrum wireless communication system called ultra-wide bandwidth (UWB) radio is employed to provide communications that are low power, high data rate, fade resistant, and relatively shadow free in a dense multipath environment [5]–[7]. UWB radios, operating with low transmission power in an extremely large transmission bandwidth, have also been under consideration for future military networks because they inherently provide a covertness property with low probability of detection and interception (LPD/LPI) [8], [9]. This radio-communication technique also has commercial applications, especially for short-range or indoor wireless communications, e.g., high-speed wireless LAN's, wireless full-motion video communications, the augmented industrial workplace, and high-quality studio applications.

Furthermore, an ATM-based network model is presented which merges the concepts of both broadband networks and personal communications. This model is based upon: 1) a broadband, wired, ATM backbone network supporting cell transport and 2) a high-speed UWB radio subsystem. An ATM network is chosen due to its high bandwidth, fast switching capability, and flexibility. A high-speed UWB-radio subsystem consists of:

- an enhanced mobile switching center (EMSC), which connects to the ATM network on one side and to a group of base stations on the other side;

- radio base stations, each of which serves as the interface between the wired network and the portable communication units;
- portable communication units, each of which is the interface between the end user and the communication system, which transforms the user-generated signal into a suitable form to be transmitted over the radio channel.

As will be explained, this model exploits and generalizes the ATM concept in the wireless scenario to support high data rate radio transmission and frequent handoffs among base stations.

ATM was originally designed for wired systems and stationary users. The user-network interface is a fixed port that remains stationary during the connection. The basic transmission mechanisms in ATM are virtual path (VP) and virtual circuit (VC), which need to be established at the beginning of a connection, maintained throughout the connection, and terminated afterwards. After the connection is established, a certain amount of resource is reserved along the path from the source to the destination to guarantee the QoS. Since the user is stationary, the established connection and the corresponding resource allocation remains fixed during the lifetime of the connection. However, in PCS, user mobility or changes in channel conditions cause a user's network access point to change over time. The user's connection needs to be rerouted to the new base station once a handoff occurs, which in principle implies that the connection has to be reestablished, and the bandwidth has to be reallocated. If the connection setup and resetup are controlled by the network call processor, frequent handoffs, especially in micro- or picocell systems, involve the network call processor many times during the lifetime of a single connection, making it the bottleneck of the system. To alleviate this problem, a hierarchical network configuration and wireless VC (WVC) concept are proposed. In our system, EMSC isolates the wireless subsystem from the fixed ATM backbone network. Generalizing the VC concept of ATM in the wireless scenario, there are two types of VC's in the network: a WVC connecting the portable units to EMSC and ATM VC's providing the connection in the fixed network. When a user is roaming, the fixed portion of the VP/VC pair need not be changed as long as the user remains in the same EMSC serving area. Only the wireless portion needs to be updated as the user moves to a new cell. The WVC number (WVCN) is assigned by the EMSC, which remains the same until the user handoffs to another EMSC. The advantage of WVC will be explained in detail in the following sections.

### B. Introduction to UWB-Radio Systems

The term *wideband*, as applied to communication systems, can have different meanings. When applied to conventional systems, it refers to the data-modulation bandwidth. In that case, the more wideband a system is, the higher its data transmission rate. In this paper, a spread-spectrum system [10], [11] is described in which the transmitted signal, even in the absence of data modulation, occupies an extremely large bandwidth. In this case, with a fixed data modulation rate, as the transmitted-signal bandwidth increases, the signal becomes more covert because its power density is lower, has higher

immunity to the effects of interference, and has improved time-of-arrival resolution.

The spread-spectrum radio system described here is unique in another regard: it does not use sinusoidal carriers to raise the signal to a particular frequency band in which signals propagate well, but instead communicates with a time-hopping baseband signal composed of subnanosecond pulses (referred to as *monocycles*). Since its bandwidth ranges from near dc to several GHz, this *UWB-radio* signal undergoes distortions in the propagation process, even in very benign propagation environments. On the other hand, the fact that an UWB-radio system operates in the lowest possible frequency band that supports its wide transmission bandwidth means that this radio has the best chance of penetrating materials that tend to become more opaque at higher frequencies.

Finally, it should be noted that the use of signals with GHz bandwidths implies that multipath is resolvable down to path differential delays on the order of a nanosecond or less, i.e., down to path-differential lengths on the order of a foot or less. This significantly reduces fading effects, even in indoor environments, and the resulting reduction of fading margins in link power budgets leads to reduced transmission power requirements. The modulation format described in this paper can be supported by current technology. The receiver-signal processing and performance predictions for digital-data modulation formats are considered under ideal multiple-access channel conditions. Real indoor-channel measurements and their implications for Rake-receiver design are discussed in [12] and [13].

## II. NETWORK ARCHITECTURE

The general aim of this paper is to design a broadband wireless network to provide seamless extensions of wired ATM network capabilities in the radio environment in a relatively transparent and efficient manner. There are several factors that tend to favor the use of ATM, including: flexible bandwidth allocation, fast switching, and multiple-service type selection. However, ATM was originally designed for stationary users and wired networks. To use it in a wireless environment, the impact of mobility on the network architecture must be taken into account.

### A. Hierarchical Network Control Architecture

A hierarchical network control architecture is illustrated in Fig. 1, which supports fixed ATM connections as well as radio connections. There are two levels of controllers in the wireless subsystem, namely, the base stations, each of which serves one particular cell, and the EMSC's, each of which manages a group of base stations in a relatively large area. The base station is the access point for mobile users and is responsible for the control and maintenance of connections between the EMSC and the mobile user. The EMSC acts as the interface between the wireless subsystem and the ATM backbone network. Every transmission request generated by a mobile user is sent to the EMSC through an appropriate base station for examination. Note that the identification number (ID) of the currently serving base station, which can be obtained through the downlink (base station to mobile) broadcast channel, is included in this request message.

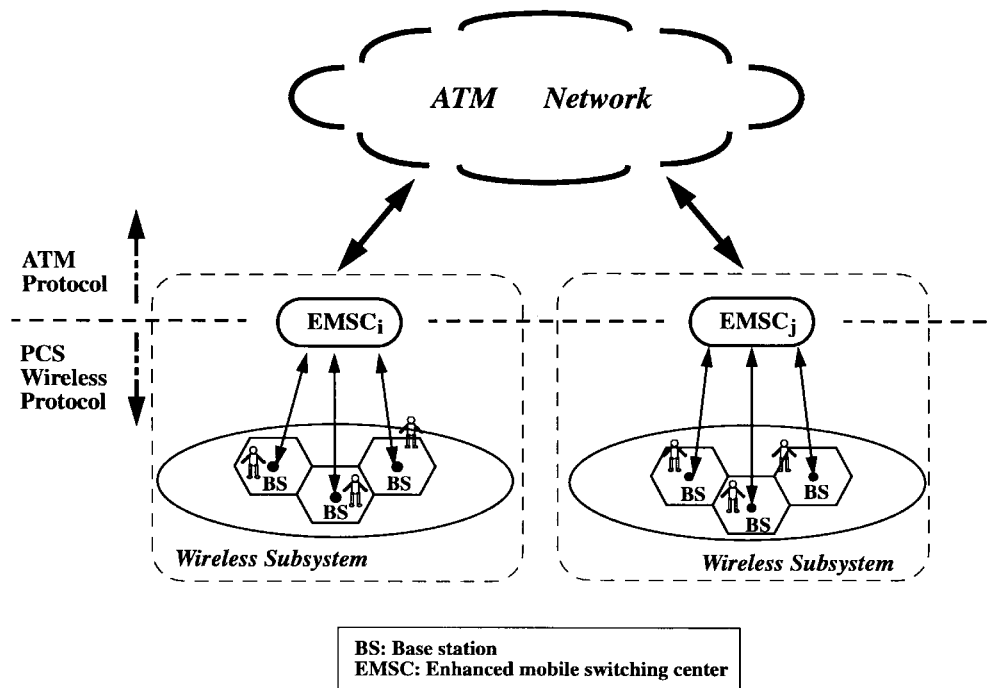

Fig. 1. The hierarchical network architecture for high-speed PCS.

If admission is granted, the ID is recorded by the EMSC in its lookup table. If the destined user is within the service area of the same EMSC, the connection is established directly between these two users through the EMSC and the appropriate base stations. Otherwise, the EMSC sets up and maintains a wireline connection between the base stations serving these two users through the ATM network.

The call setup procedure is executed in two steps. First, the WVC is established between the EMSC and the portable unit by assigning a WVCN to the user and reserving a certain amount of resource along the wireless VP. The WVCN is maintained until the user hands off to another EMSC. Only the actual wireless connection needs to be changed when the user hands off from one base station to another. In order to implement this hierarchical architecture, two fields in the wireless data packet are necessary, namely, the WVCN field and the base-station ID field. Of course, there are other fields needed for control- and error-correction purposes. Second, the fixed portion of the virtual connection is established between the EMSC and the appropriate fixed point of the wired network (the destined wired user or the corresponding EMSC of the destined radio user). As long as the user remains in the same EMSC serving area, this fixed portion of the virtual connection need not be changed.

EMSC translates WVCN to the VC number (VCN) which is needed to switch the ATM cells along the appropriate wired path. EMSC records the currently serving base-station ID in the lookup table associated with WVCN to facilitate the downlink transmission. When an intra-EMSC handoff occurs, the user simply transmits the packets with the same WVCN, but different base-station ID, in the corresponding fields. The traffic flows from the user to the new base station and to the EMSC through the fixed portion of the ATM network and to the final destination. The old WVC connection is terminated

after the transition to the new base station is completed successfully.

When the user reaches the boundary of an EMSC serving area, it seeks admission to a new EMSC. This is referred to as an inter-EMSC handoff. At this point, the fixed portion of the connection needs to be modified to reflect this change. Several techniques can be used, including a virtual connection tree algorithm [2], an entire virtual connection reestablishment, a partial virtual connection rebuild, a simple extension with loop reduction, etc. [14]. However, since the geographical area controlled by the EMSC is relatively large compared to the size of a radio cell, the rate of inter-EMSC handoffs is expected to be low.

### B. Protocol Layering for a Wireless Subsystem

With the network architecture defined earlier, the wireless protocol layers are designed based on the wireless subsystem characteristics, as illustrated in Fig. 2. Existing ATM protocols are used for the backbone network to take advantage of the well-developed ATM infrastructure. Among all the network control functions on the mobile-user side, the most distinguished ones are to establish and to maintain the WVC. To simplify the functionality and reduce the cost of the base station, only two layers are implemented at it—the physical layer and the data link layer. The physical layer deals with the mechanical, electrical, and procedural interfaces, and the physical transmission medium that lies below it. The major functions in the data link layer are to manage the media access and to provide the basic link-level error control and flow-control capabilities.

Most of the network control functions are implemented in the EMSC. In addition to the traditional functions of the MSC in cellular systems, the EMSC in our proposed system has the enhanced capabilities to manage the WVC and ATM VP/VC

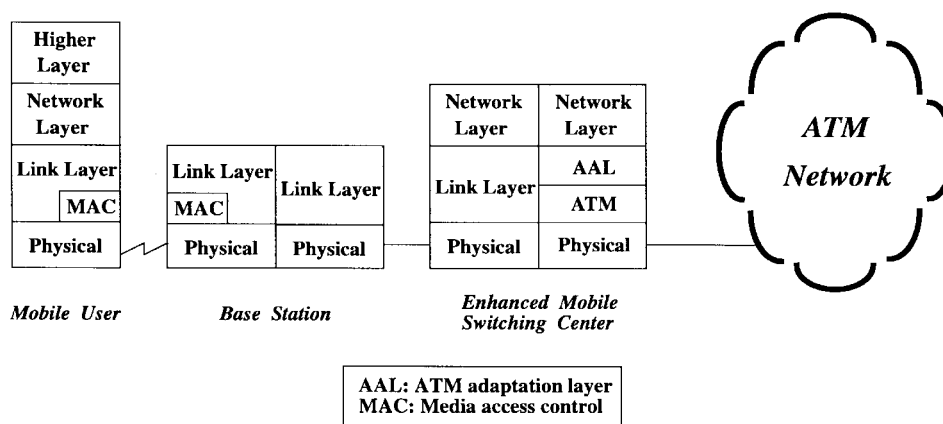

Fig. 2. The protocol layer design for the wireless subsystem.

pairs: it provides the admission control and the assignment of time-hopping sequences and converts the message format between the wireless packet and the ATM cell. Two stacks of protocols are implemented in the EMSC, one for the wireless subsystem and another for the ATM network. Note that there are other proposals using the same stack of ATM protocols for both wired and wireless systems by adding new features to handle the special needs of radio channels, e.g., [3]. Which way is better is still an open problem and deserves careful investigation.

### C. Time-Hopping Spread-Spectrum Multiple Access

There is much debate regarding which multiple-access scheme should be used in wireless ATM to provide high-spectrum efficiency. In this paper, we present a time-hopping spread-spectrum technique for multiple-access purposes (TH-SSMA). We employ the TH-SSMA because of its advantages in the presence of interference and multipath fading typical of the radio medium, especially in the indoor environment. Each user who initiates communication sends a request to the corresponding base station and EMSC through the uplink request channel. Upon receiving this request, the EMSC makes the admission decision based on the availability of both wired and radio resources. Each admitted user starts the data transmission after being assigned a unique time-hopping sequence. The TH-SSMA operates *asynchronously* in a resource-sharing packet mode, which is quite efficient for providing multimedia services. Specifically, in the TH-SSMA, any user can transmit at any time using a unique hopping sequence at a desired data rate without coordination with other users.

In our wireless subsystem, both connectionless and connection-oriented services can be supported. For example, the total bandwidth in the uplink is divided into two parts: 1) the uplink request channel and 2) the uplink traffic channel. The request channel is designed for the transmission of various control information, channel access requests, handoff requests, and short data messages. A random-access mode is employed on this channel. The connectionless transmission goes through the uplink request channel directly without waiting for the assignment of a time-hopping sequence in order to shorten the access latency and simplify the network control. The

connection-oriented transmission is provided by the normal traffic channel using the UWB time-hopping technique.

### D. WVC

The basic transmission mechanisms in ATM are VP and VC, which need to be established at the beginning of a connection, maintained throughout the connection, and terminated afterwards. However, in the wireless subsystem, since the user is moving frequently, it is difficult to maintain an end-to-end ATM connection. Therefore, the idea is to divide the end-to-end connection into two portions: 1) the conventional wired ATM portion and 2) the wireless last hop. The wired portion is maintained as long as possible and the wireless portion is changing along with the user's movement. We extend the ATM VC concept into the wireless portion, referring to it as WVC.

Another advantage of this division is that error control can be implemented in the EMSC, preventing transmission errors from propagating into the wired network. In the conventional ATM system, error control is not performed inside the network, and only end-to-end protection is provided at the transport layer because of the extremely low transmission error rate [15]. Due to the harsh conditions of the radio channel, the error rate is much higher than in a wired system. Therefore, the conventional end-to-end protection is not efficient because of the wasted bandwidth in the wired system when frequent retransmissions occur due to the transmission errors in the radio channel. One way to solve this problem is to correct most of the radio-channel errors before they enter the wired network. Different error-control schemes, including both forward error correction (FEC) and retransmission, can be used for different portions of the connection depending on the service type. Finally, end-to-end protection is provided at the transport layer.

The integration of a WVC and an ATM VP/VC is illustrated in Fig. 3, using the connection between two mobile users as an example. The WVC's from the initiating mobile user to its EMSC and from the ending EMSC to the destined mobile user are connected by an ATM VP/VC. If the mobile user only changes its serving base station but not the EMSC, the existing ATM VP/VC need not be changed. Only the WVC needs to be maintained and reestablished when the handoff occurs. The key advantage of this network architecture and WVC concept

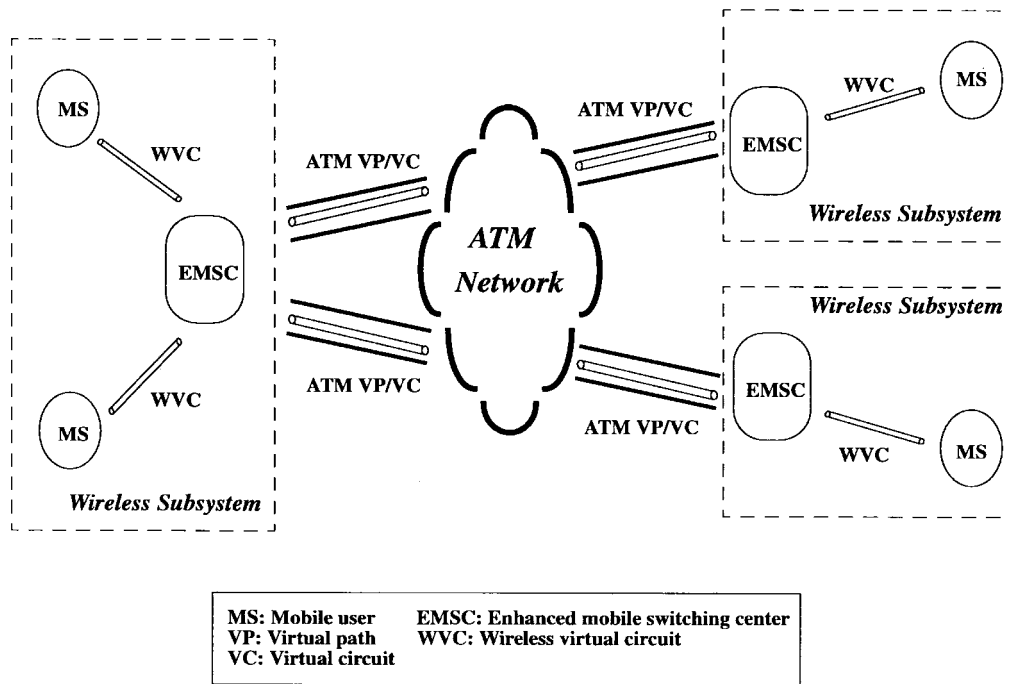

Fig. 3. An illustration of the WVC.

is that most of the handoffs can be done quickly and easily by the local EMSC, due to the localized behavior of PCS users.

### III. UWB RADIO: THE PHYSICAL LAYER

#### A. Time-Hopping Format Using Impulses

A typical time-hopping format employed by an UWB radio in which the  $k$ th transmitter's output signal  $s_{\text{tr}}^{(k)}(t^{(k)})$  is given by

$$s_{\text{tr}}^{(k)}(t^{(k)}) = \sum_{j=-\infty}^{\infty} w_{\text{tr}}\left(t^{(k)} - jT_f - c_j^{(k)}T_c - \delta d_{\lfloor j/N_s \rfloor}^{(k)}\right) \quad (1)$$

where  $t^{(k)}$  is the  $k$ th transmitter's clock time, and  $w_{\text{tr}}(t)$  represents the transmitted pulse waveform, referred to as a *monocycle*, that nominally begins at time zero on the transmitter's clock.

The *frame time* or *pulse-repetition time*  $T_f$  is typically a hundred to a thousand times the monocycle width, resulting in a signal with a very low duty cycle. To eliminate catastrophic collisions due to multiple access, each user (indexed by  $k$ ) is assigned a distinctive time-shift pattern  $\{c_j^{(k)}\}$  called a *time-hopping sequence*, which provides an additional time shift to each monocycle in the pulse train. The  $j$ th monocycle undergoes an additional shift of  $c_j^{(k)}T_c$ , where  $T_c$  is the duration of the addressable time-delay bin. The elements  $c_j^{(k)}$  of the sequence are chosen from a finite set  $\{0, 1, \dots, N_h - 1\}$ , and hence hop-time shifts from zero to  $N_h T_c$  are possible. The addressable time-hopping duration is strictly less than the frame time since a short time interval is required to read the output of a monocycle correlator and to reset the correlator.

For performance prediction purposes, the data sequence  $\{d_j^{(k)}\}_{j=-\infty}^{\infty}$  is modeled as a wide-sense stationary (WSS)

random process composed of equally likely binary symbols. Pulse-position modulation (PPM) is considered here. It is assumed that the data stream is balanced so that the S-curve of the clock tracking loop can maintain a stable tracking point. With more complicated schemes, pulse-shift balance can be achieved in each symbol time. The parameter  $\delta$  is a modulation parameter, which can be chosen to optimize performance. If  $\delta > T_m$ , then the transmitted signals representing zero and one are orthogonal.

#### B. The Multiple-Access Channel

When  $N_u$  users are active in the multiple-access system, the composite received signal  $r(t)$  at the output of the receiver antenna is modeled as

$$r(t) = \sum_{k=1}^{N_u} A_k s_{\text{rec}}^{(k)}(t - \tau_k) + n(t) \quad (2)$$

where  $s_{\text{rec}}^{(k)}(t - \tau_k)$  is the received signal from the  $k$ th transmitter, and  $A_k$  represents its attenuation over the propagation path. The random variable  $\tau_k$  represents the time asynchronism between the clock of transmitter  $k$  and the receiver, and  $n(t)$  represents other nonmonocycle interference (e.g., receiver noise) present at the correlator input.

The number of active transmitters  $N_u$  and their signal amplitudes  $A_k$  are assumed to be constant during the data-symbol interval. The propagation of the signals from each transmitter to the receiver is assumed to be ideal, i.e., each signal undergoes only a constant attenuation and delay. The antenna/propagation system modifies the shape of the transmitted monocycle  $w_{\text{tr}}(t)$  to  $w_{\text{rec}}(t)$  at its output. An idealized received monocycle shape  $w_{\text{rec}}(t)$  for a free-space channel model is shown in Fig. 4. This channel model ignores multipath, and dispersive effects.

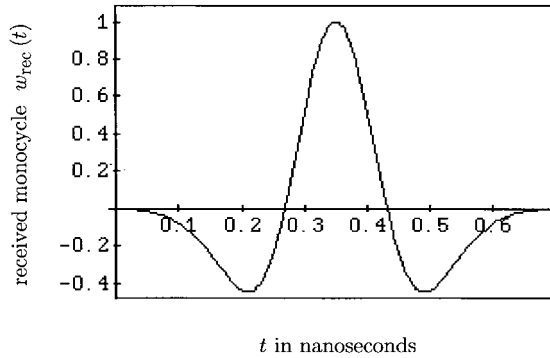

Fig. 4. A typical received monocycle  $w_{\text{rec}}(t)$  at the output of the antenna subsystem as a function of time in nanoseconds.

### C. UWB Receiver Signal Processing

The optimum receiver for a single bit of a binary modulated UWB-radio signal in additive white Gaussian noise (AWGN) is a correlation receiver [5], [16], [17], which can be written as shown in (3) (shown at the bottom of the page), where the *correlation template signal* is  $v(t) \triangleq w_{\text{rec}}(t) - w_{\text{rec}}(t - \delta)$ .

Optimal detection in a multiuser environment, with knowledge of all time-hopping sequences, leads to complex receiver designs [18]–[20]. However, if the number of users is large, and no such multiuser detector is feasible, then it is reasonable to approximate the combined effect of the other users' dehopped interfering signals as a Gaussian random process [5], [6]. Hence, the single-link reception algorithm (3) is used here as a theoretically tractable receiver model, amenable as well to practical implementations.

The test statistic  $\alpha$  in (3) consists of summing the  $N_s$  correlations  $\alpha_j$  of the correlator template signal  $v(t)$  with the received signal  $r(t)$  at various time shifts. The signal processing corresponding to this decision rule in (3) is shown in Fig. 5. A graph of the template signal is shown in Fig. 6 using the typical received waveform given in Fig. 4.

### D. Signal-to-Noise Ratio Calculation

Using the approach of [21], the average output signal-to-noise ratio of the UWB radio is calculated in [5] for randomly selected time-hopping sequences as a function of the number of active users  $N_u$

$$\text{SNR}_{\text{out}}(N_u) = \frac{(N_s A_1 m_p)^2}{\sigma_{\text{rec}}^2 + N_s \sigma_a^2 \sum_{k=2}^{N_u} A_k^2}. \quad (4)$$

Here,  $\sigma_{\text{rec}}^2$  is the variance of the receiver-noise component at the pulse-train integrator output. The monocycle waveform-

dependent parameters  $m_p$  and  $\sigma_a^2$  in (4) are given by

$$m_p = \int_{-\infty}^{\infty} w_{\text{rec}}(x - \delta) v(x) dx \quad (5)$$

and

$$\sigma_a^2 = T_f^{-1} \int_{-\infty}^{\infty} \left[ \int_{-\infty}^{\infty} w_{\text{rec}}(x - s) v(x) dx \right]^2 ds \quad (6)$$

respectively.

### E. Performance Measures of a UWB Radio

The performance of a UWB radio in terms of multiple-access capacity is derived for a specified level of uncoded bit error rate (BER) and other modulation parameters. Multiple-access capacity is defined as the number of users that the system can support for a given data rate.

The  $\text{SNR}_{\text{out}}(N_u)$  of the UWB radio can be rewritten as follows, after some algebraic manipulation

$$\text{SNR}_{\text{out}}(N_u) = \left\{ \text{SNR}_{\text{out}}^{-1}(1) + M \sum_{k=2}^{N_u} \left( \frac{A_k}{A_1} \right)^2 \right\}^{-1} \quad (7)$$

where

$$\text{SNR}_{\text{out}}(1) \triangleq \frac{(N_s A_1 m_p)^2}{\sigma_{\text{rec}}^2} \quad (8)$$

and the parameter  $M$  is given by

$$M^{-1} \triangleq \frac{N_s m_p^2}{\sigma_a^2}. \quad (9)$$

Let us suppose that a specified signal-to-noise ratio  $\text{SNR}_{\text{spec}}$  must be maintained for the link to satisfy a performance specification. If this specification is to be met when  $N_u - 1$  other users are active, then it follows that  $\text{SNR}_{\text{out}}(1)$  in (7) represents the required equivalent single link signal-to-noise ratio (ignoring multiple-access noise) such that  $\text{SNR}_{\text{out}}(N_u) = \text{SNR}_{\text{spec}}$ . Therefore, the ratio of  $\text{SNR}_{\text{out}}(1)$  to  $\text{SNR}_{\text{out}}(N_u)$ , with  $\text{SNR}_{\text{out}}(N_u) = \text{SNR}_{\text{spec}}$ , represents the fractional increase in every transmitter's power. This increased power is required to maintain the received signal-to-noise ratio at a level of  $\text{SNR}_{\text{spec}}$  in the presence of multiple-access interference caused by  $N_u - 1$  other users. We define this fractional increase in required power (in units of dB) as

$$\Delta P \triangleq 10 \log_{10} \{ \text{SNR}_{\text{out}}(1) / \text{SNR}_{\text{spec}} \}. \quad (10)$$

Under the assumption of perfect power control and for a given data rate, the number of users that the multiple-access UWB-radio system can support on an aggregate AWGN channel is shown in [7] to be

$$N_u(\Delta P) = \left\lfloor M^{-1} \text{SNR}_{\text{spec}}^{-1} \left\{ 1 - 10^{-(\Delta P/10)} \right\} \right\rfloor + 1 \quad (11)$$

---

$$\text{"decide } d_0^{(1)} = 0\text{"} \Leftrightarrow \underbrace{\sum_{j=0}^{N_s-1} \int_{\tau_1+jT_f}^{\tau_1+(j+1)T_f} r(t)v(t-\tau_1-jT_f-c_j^{(1)}T_c) dt}_{\text{test statistic } \triangleq \alpha} > 0. \quad (3)$$

pulse correlator output  $\triangleq \alpha_j$

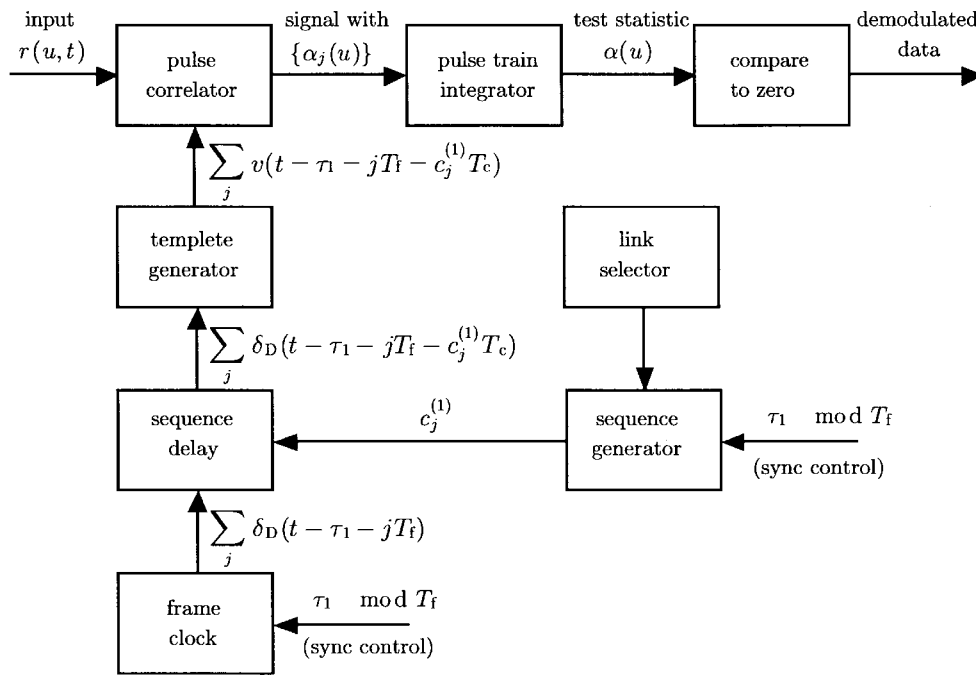

Fig. 5. Receiver block diagram for the reception of the first user's signal. Clock pulses are denoted by Dirac delta functions  $\delta_D(\cdot)$ .

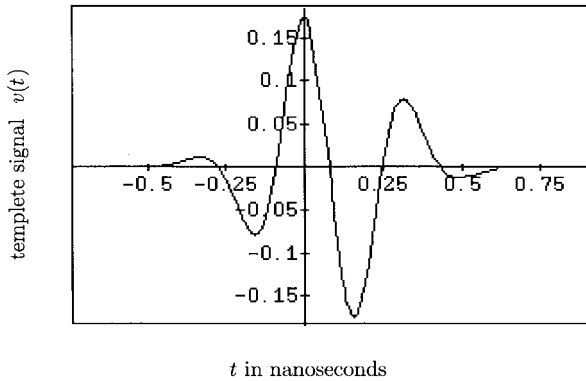

Fig. 6. The template signal  $v(t)$  with the modulation parameter  $\delta$  chosen to be 0.156 ns. Since the template is a difference of two pulses shifted by  $\delta$ , the nonzero extent of the template signal is approximately  $\delta$  plus the monocycle width, i.e., about 0.86 ns.

which is a monotonically increasing function of  $\Delta P$ . Therefore

$$\begin{aligned} N_u(\Delta P) &\leq \lim_{\Delta P \rightarrow \infty} N_u(\Delta P) \\ &= \lceil M^{-1} \text{SNR}_{\text{spec}}^{-1} \rceil + 1 \triangleq N_{\text{max}}. \end{aligned} \quad (12)$$

Hence, the number of users at a specified BER based on  $\text{SNR}_{\text{spec}}$  cannot be larger than  $N_{\text{max}}$ , no matter how large each user's signal power. In other words, when the number of active users is more than  $N_{\text{max}}$ , the receiver cannot maintain the specified level of performance regardless of the additional available power. Similar results for direct-sequence code division multiple access (CDMA) systems can be found in [21].

#### F. Performance Evaluation of Multiple-Access Systems

The performance of the UWB-radio receiver in a multiple-access environment is evaluated using a specific example. The

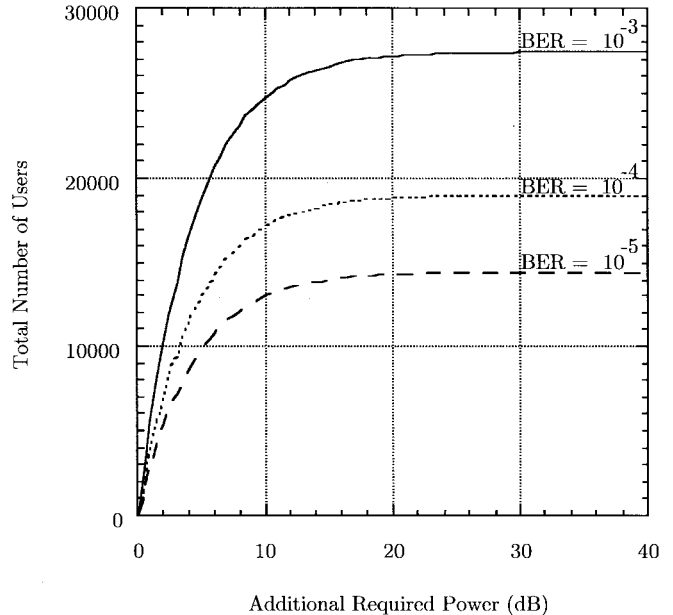

Fig. 7. Total number of users versus additional required power (dB) for the UWB radio example. Ideal power control is assumed at the receiver. Three different BER performance levels with the data rate set at 19.2 Kbit/s are considered.

duration of a single symbol used in this example is  $T_s = N_s T_f$ . For a fixed-frame (pulse-repetition) time  $T_f$ , the *symbol rate*  $R_s$  determines the number of modulated monocycles per symbol  $N_s$  via the equation  $R_s = 1/T_s = 1/N_s T_f \text{ s}^{-1}$ .

The modulation parameter  $\delta$  in (1), which affects the shape of the template signal  $v(t)$ , affects performance only through  $m_p$  and  $\sigma_a^2$  implicitly and can be adjusted to maximize  $\text{SNR}_{\text{out}}(N_u)$  under various conditions. When the receiver noise dominates the multiple-access noise, e.g., when there

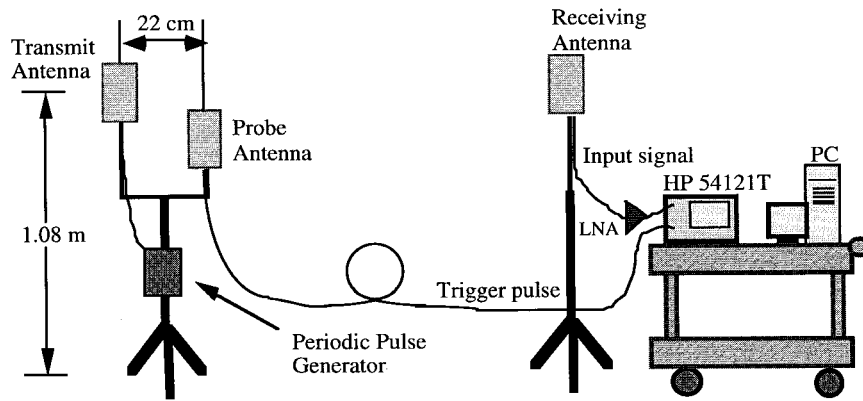

Fig. 8. A block diagram of the measurement apparatus.

is only one user or when there is a strong external interferer, then it can be shown that the optimum choice of modulation parameter is the one that maximizes  $|m_p|$ . On the other hand, when the receiver noise is negligible and  $\text{SNR}_{\text{out}}(1)$  is nearly infinite, then the optimum choice of  $\delta$ , suggested by (4), is the one that maximizes  $|m_p|/\sigma_a$ . For the monocycle waveform of Fig. 4 which we use in this example, these considerations imply that  $\delta$  should be chosen as either 0.144 or 0.156 ns, and little is lost in choosing either of these values. Choosing  $\delta = 0.156$  ns and  $T_f = 100$  ns gives  $m_p = -0.1746$ ,  $\sigma_a^2 = 0.006045$ , and the unitless constant that is required for calculating  $M^{-1}$  in (9) is  $m_p^2/\sigma_a^2 \approx 504$ . With a data rate  $R_s = 19.2$  kbit/s, the quantity  $M^{-1}$  is calculated to be  $2.63 \times 10^5$ .

The number of users versus additional required power  $\Delta P$  for multiple-access operation with ideal power control is plotted for typical BER's in Fig. 7 for this example. To maintain a BER of  $10^{-3}$ ,  $10^{-4}$ , and  $10^{-5}$  in a communications system with no error-control coding,  $\text{SNR}_{\text{spec}}$  must be 12.8, 14.4, and 15.6 dB, respectively. Note that the number of users increases rapidly as  $\Delta P$  increases from 0 to 10 dB. However, this improvement becomes gradual as  $\Delta P$  increases from 10 to 20 dB. Beyond this point, only negligible improvement can be made as  $\Delta P$  increases and  $N_u$  approaches  $N_{\text{max}}$ . In practice, UWB radios are expected to operate in regions where the increase in the number of users as a function of  $\Delta P$  is rapid. The values of  $N_{\text{max}}$  are calculated to be 27488, 19017, and 14426 for BER's of  $10^{-3}$ ,  $10^{-4}$ , and  $10^{-5}$ , respectively, and these are the asymptotic values on the curves in Fig. 7. It is worth noting that if a direct-sequence CDMA system with roughly the same bandwidth were analyzed, one would find comparable numbers of users in the same communication environment.

#### IV. UWB-SIGNAL PROPAGATION EXPERIMENT

##### A. Motivation

Propagation environments place fundamental limitations on the performance of wireless communications systems. The existence of multiple propagation paths (multipath) with different time delays gives rise to a complex time-varying transmission channel. A line-of-sight path between the transmitter and

receiver seldom exists in indoor environments because of blocking, and one must rely on the signal arriving via the multipath.

Many propagation measurements have been made over the years on both indoor and outdoor environments with much "narrower bandwidths." A comprehensive reference on indoor propagation channels (a total of 281 references) can be found in the excellent tutorial survey paper by Hashemi [22]. However, these measurements are inadequate, and the characterization of the UWB-signal propagation channel has not been available previously in the literature. Careful characterization of the UWB propagation channel is required to move beyond current limits and to determine methods for achieving robust, fade-resistant, high-quality mobile communications.

##### B. Experimental Results

The measurement technique employed here is to probe the channel periodically with a subnanosecond pulse and to record the response of the channel using a digital sampling oscilloscope (DSO). Path resolution down to about one ns of differential delay, corresponding to about one foot of differential path length, is possible without special processing. The repetition rate of the pulses is  $2 \times 10^6$  pulses per second, implying that multipath spreads up to 0.5 microsecond can be observed unambiguously.

A block diagram of the measurement apparatus is shown in Fig. 8. One of the three UWB antennas is set in close proximity to the transmit antenna to supply a trigger signal to the DSO over a long fixed-length coaxial cable. Therefore, all recorded multipath profiles have the same absolute delay reference, and time delay measurements of the signals arriving at the receiving antenna via different propagation paths can be made. During each of the multipath profile measurements, both the transmitter and receiver are kept stationary. Multipath profiles were measured at various locations in 14 rooms and hallways throughout the building. In each room, 300-ns long response measurements were made at 49 different locations over a 3 ft  $\times$  3 ft square grid. They are arranged spatially in a 7  $\times$  7 square grid with a 6-in spacing between spatial sample points.

Typical examples of multipath profiles measured over 1  $\mu$ s in three different offices are shown in Fig. 9. The approximate



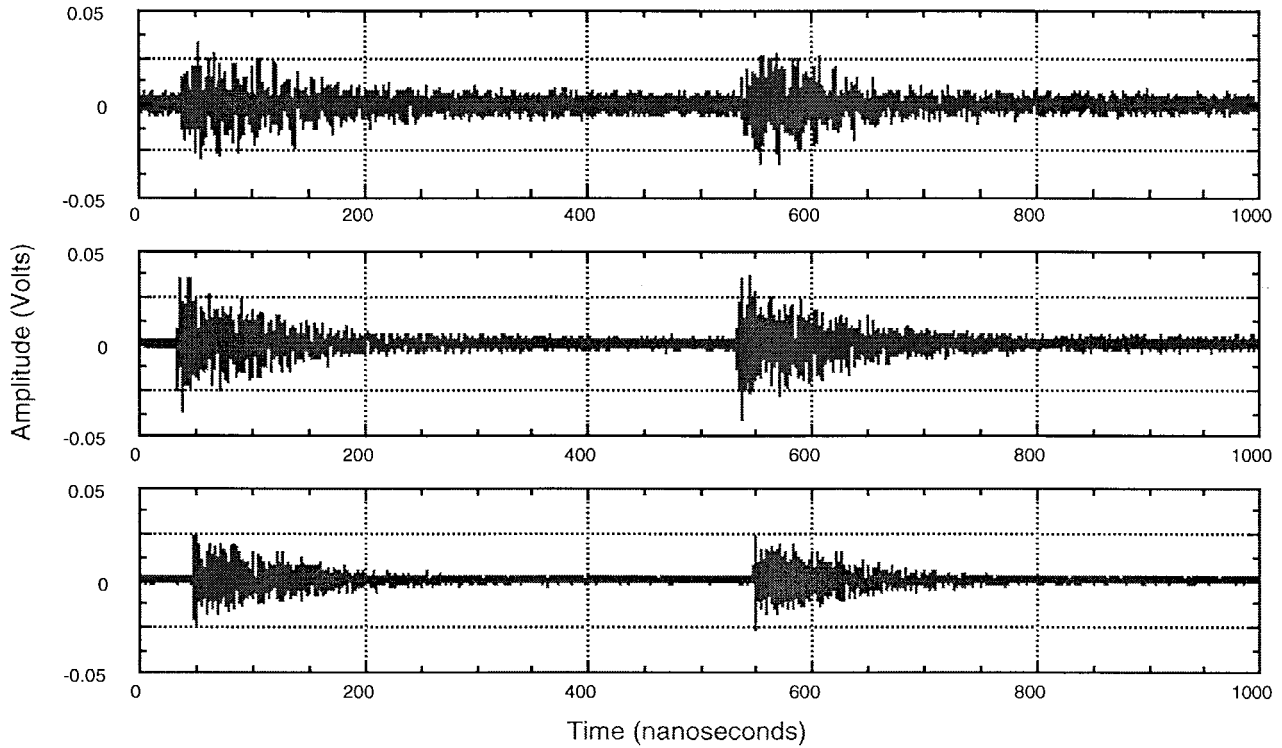

Fig. 9. Average multipath measurements of 32 sequentially measured multipath profiles where the receiver is located at the same exact positions in three different offices. The measurement grids are 10, 8.5, and 13.5 m away from the transmitter, respectively.

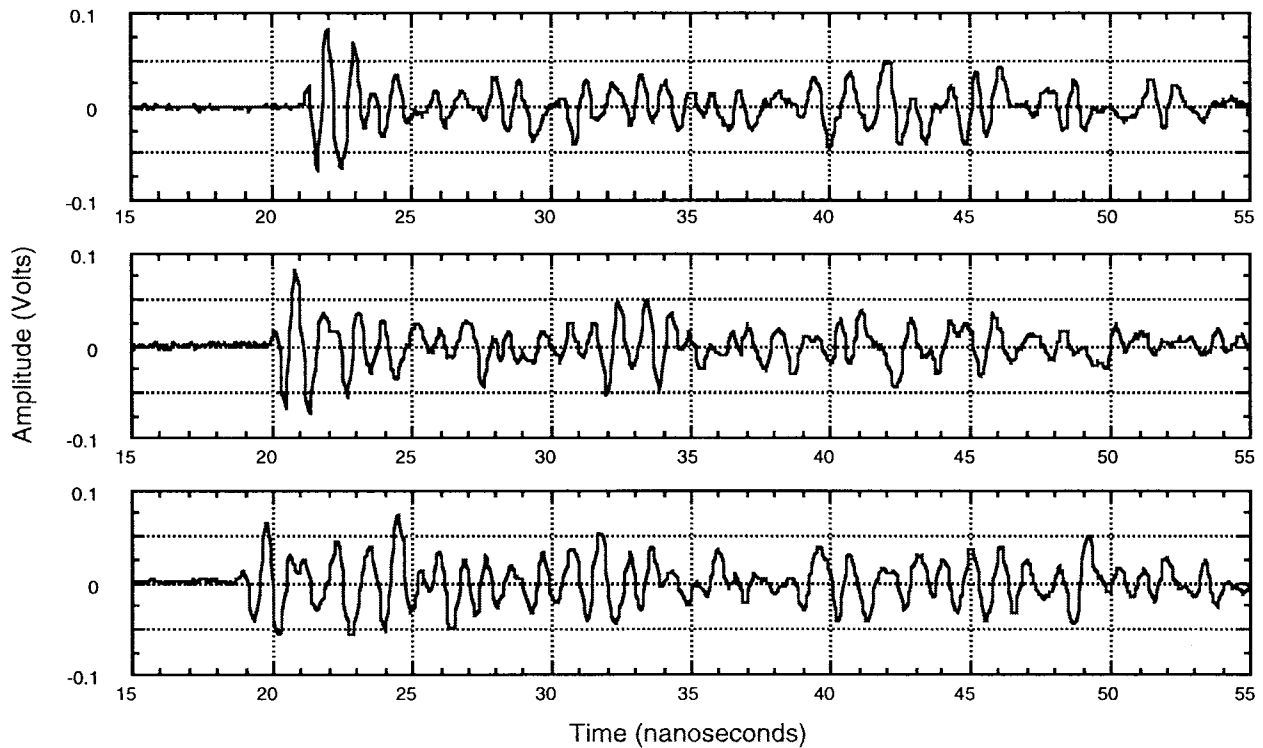

Fig. 10. Averaged multipath profiles in a 40 ns window, measured in an office along the horizontal cross section of the grid at three different aligned positions of 18 in. apart. The transmitter is approximately 6 m from the receiver, representing typical UWB-signal transmissions for the "high signal-to-noise ratio" environment.

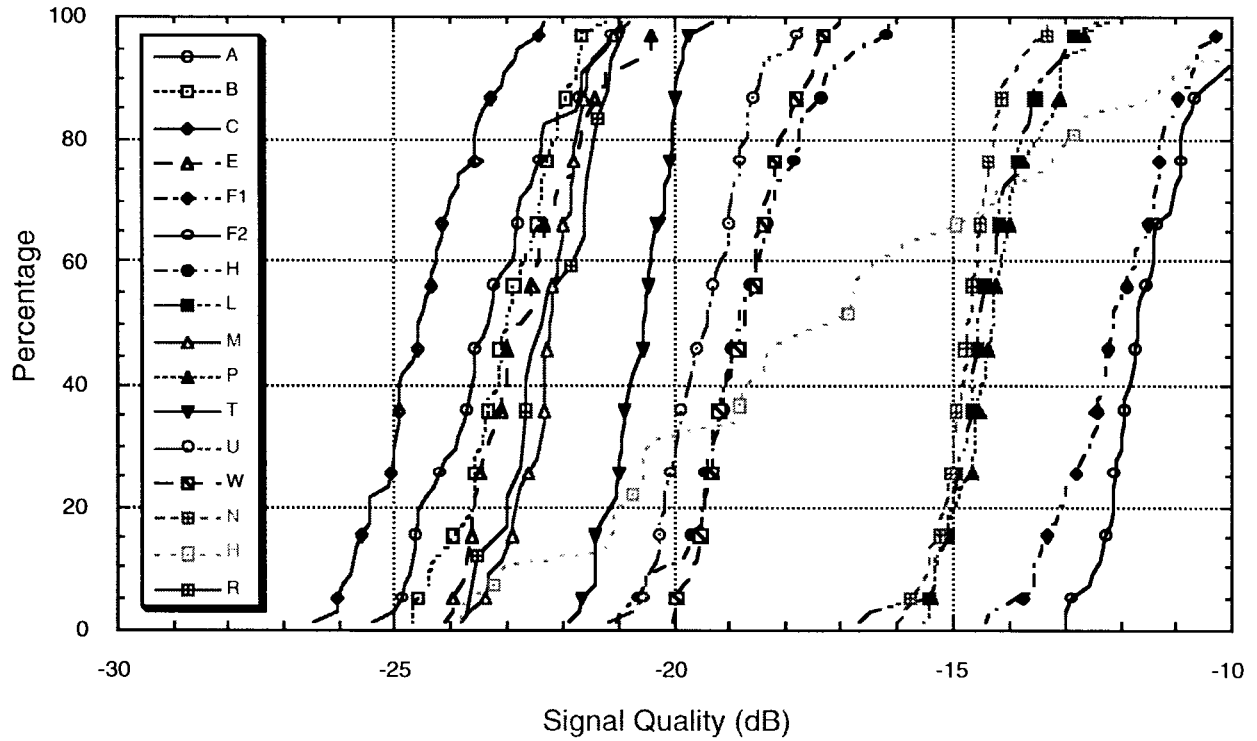

Fig. 11. The cumulative distribution function of the signal quality based on 49 spatial sample points (except 21 spatial points for room R and 34 spatial points for hallways) in each room. A total of 741 measurements were used in this plot.

distances between the transmitter and the locations of these measurements are 10, 8.5, and 13.5 m, respectively. Fig. 9 also shows that the response to the first probing pulse has decayed almost completely in roughly 200 ns, and it has disappeared before the response to the next pulse arrives at the antenna. Fig. 10 shows the averaged multipath profiles measured in an office at three different aligned positions 18 in apart in the measurement grid. The position of the receiving antenna grid is approximately located 6 m away from the transmitter, representing typical UWB signal transmission for the “high signal-to-noise ratio” environment. Notice that the leading edge of the direct path response suggests that the location of the receiver for the lower trace is closer to the transmitter than that of the upper trace. Multipath delay spread on the order of 100 nanoseconds is observed.

### C. Nonmodel-Based Multipath-Channel Characterization

An accurate statistical characterization of the propagation channel is crucial in many aspects of communication systems engineering, such as deriving optimal methods, estimating the system performance, performing design tradeoffs, etc. Assuming that the basic received pulse  $w(t)$  is known, a received-signal model is given by

$$r(t) = \underbrace{c(t) * w(t)}_{\triangleq s(t)} + n(t) \quad (13)$$

where  $c(t)$  is the multipath channel and  $n(t)$  is the observation noise. Next, we describe characterization of the propagation channel *without using a specific model* for the multipath channel  $c(t)$ .

**Robustness in Multipath:** Robustness of the UWB-radio signal to multipath can be assessed by measuring the received energy at various locations in the building relative to the received energy at a reference point. Mathematically, the *signal quality* at measurement grid location  $(i, j)$  can be defined as

$$Q_{i,j} = 10 \log_{10} E_{i,j} - 10 \log_{10} E_{\text{ref}} \quad [\text{dB}]. \quad (14)$$

The received energy  $E_{i,j}$  at a location  $(i, j)$  is given by

$$E_{i,j} = \int_0^T |r_{i,j}(t)|^2 dt \quad (15)$$

where  $r_{i,j}(t)$  is the measured multipath profile at location  $(i, j)$  in the grid, and  $T$  is the observation time. The reference energy  $E_{\text{ref}}$  is chosen to be the energy in the line-of-sight path measured by the receiver located 1 m away from the transmitter.

The signal quality  $Q_{i,j}$  is calculated from the measurements made at 741 different locations (14 different rooms with 49 locations per room, 21 locations in the shield room, and 34 locations in the hallways). Table I shows the estimates of the mean and variance of the signal quality in each room based on the samples taken in that area. The cumulative distribution functions of the signal quality for measurements made in these locations are shown in Fig. 11. This data indicates that the signal energy per received multipath waveform varies by at most 5 dB as the receiving position varies over the measurement grid within a room. This is considerably less than the fading margin in narrowband systems, and indicates the potential of UWB radios for robust indoor operation at low transmitted power levels.

TABLE I  
SIGNAL QUALITY STATISTICS

Office	$\approx$ distance (meters)	Minimum (dB)	Maximum (dB)	$\hat{\mu}$ (dB)	Median (dB)	$\sqrt{\hat{\sigma}^2}$ (dB)	# of Samples
F2	5.5	-12.9970	-9.64586	-11.5241	-11.6813	0.8161	49
N	5.5	-16.0060	-13.2949	-14.7260	-14.7690	0.5892	49
P	6.0	-15.5253	-12.2185	-14.2373	-14.2820	0.8091	49
L	8.0	-16.6966	-12.4310	-14.4500	-14.5538	0.8342	49
W	8.5	-20.0157	-17.0351	-18.7358	-18.7425	0.7622	49
F1	9.5	-14.4064	-9.79770	-12.0986	-12.1407	1.0563	49
H	10.0	-21.0415	-16.1628	-18.7141	-18.8142	1.1240	49
U	10.0	-21.1719	-17.6232	-19.4275	-19.4092	0.8024	49
T	10.5	-21.9113	-19.2986	-20.6100	-20.5419	0.5960	49
R	10.5	-23.7221	-20.8867	-22.2675	-22.3851	0.8686	21
M	13.5	-23.8258	-20.9277	-22.2568	-22.2064	0.6439	49
E	13.5	-24.1454	-20.2000	-22.5973	-22.7824	1.0332	49
A	16.0	-25.4171	-20.7822	-23.2826	-23.3541	1.1512	49
B	17.0	-24.7191	-21.2006	-22.9837	-22.9987	0.8860	49
C	17.5	-26.4448	-22.3120	-24.4842	-24.5777	1.0028	49
Hallways		-23.8342	-6.72469	-16.9317	-17.3286	4.5289	34

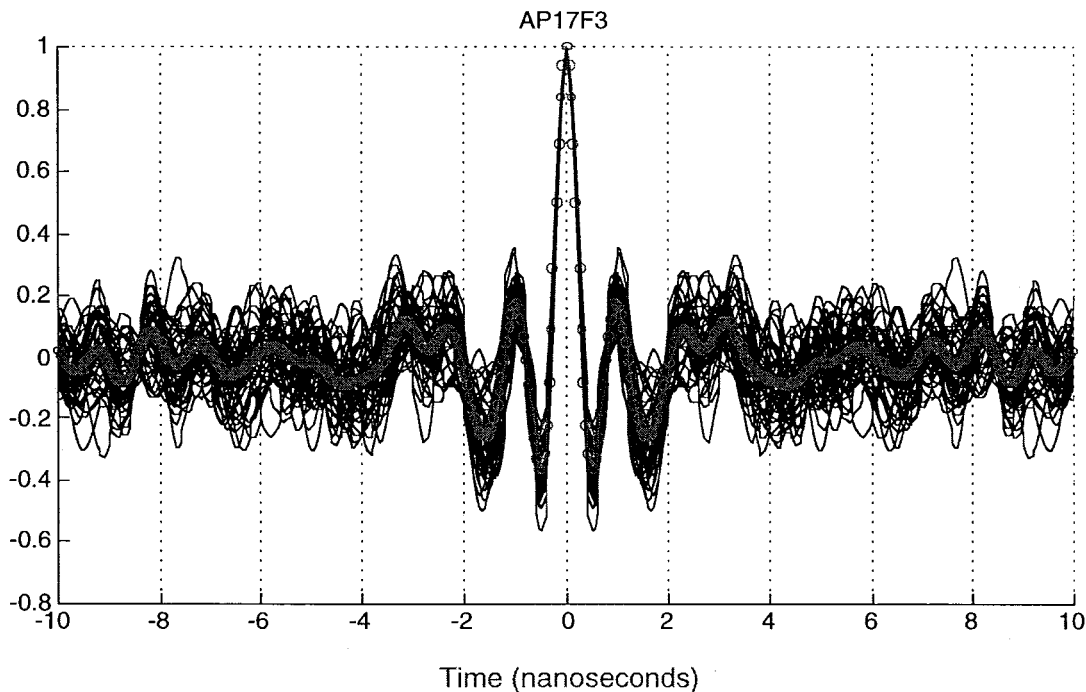

Fig. 12. Joint normalized plot of 49 different  $R_{\text{IRake}}(\zeta)$  functions obtained in an office. The transmitter is approximately 6 m from the receiver representing typical UWB-signal transmissions for the “high signal-to-noise ratio” environment.

#### D. Infinite Rake Receiver

The ultimate goal of a Rake receiver is to construct correlators or filters that are matched to the set of symbol waveforms that it must process. If the propagation measurement process is carried out by sounding the channel with the monocycle  $w_{\text{tr}}(t)$  from which a UWB radio constructs its time-hopping signal,

then the measurements can be used directly to estimate the performance of the receiver and to carry out various aspects of the receiver design.<sup>1</sup> We use the term *infinite Rake* (IRake) to

<sup>1</sup>Note that the measurements reported in Section IV were made with a pulse generator having a wider pulse width than the pulse waveform model used in Fig. 4 and Section III.

describe a receiver with unlimited resources (correlators) and infinitely fast adaptability, so that it can, in principle, construct matched filters or correlators arbitrarily well.

The performance of any ideal synchronous receiver operating over a single-link AWGN channel depends on the autocorrelation matrix of the signal set. Assuming that the multipath spread plus the maximum time-hop delay is less than the pulse-repetition time, no intersymbol or interpulse interference is present, and the performance of a perfectly synchronized UWB radio in such multipath can be predicted from the autocorrelation function  $R_{\text{IRake}}(\zeta)$  of an accurately measured multipath profile  $s(t)$  given by

$$R_{\text{IRake}}(\zeta) \approx \int_0^T s(t)s(t-\zeta) dt. \quad (16)$$

Examples of these correlation functions for the set of measurements in an office are shown in Fig. 12. As one would expect, when normalized to equal energy, these correlation functions look approximately the same for values of the shift parameter  $\zeta$  less than a pulse width ( $<1$  ns). However these correlation functions vary considerably for larger values of  $\zeta$  because the set of differential path delays varies for different points on the measurement grid. For large values of  $\zeta$ , these plots may look quite different for different rooms.

For the monocycle used to sound rooms and produce the curves of Fig. 12, a reasonable choice of the PPM data shift parameter  $\delta$  is the location of the first aggregate minimum next to the peak in these curves, roughly 0.5 ns. Notice that the BER-performance prediction varies somewhat from position to position within the measurement grid because the correlation properties of the multipath profile vary. This technique of using measured multipath profiles to evaluate signal designs has been used to compare different possible 4-ary PPM designs [23].

## V. CONCLUSION

An ATM-based TH-SSMA wireless network for multimedia PCS in dense multipath environments has been presented. A hierarchical network control infrastructure and WVC concept were proposed to reduce the impact of frequent handoffs on the ATM backbone network. The basic idea is to break the end-to-end ATM virtual connection into two parts: 1) the fixed wired ATM portion and 2) the wireless last hop. The wired portion is maintained as long as possible and the wireless portion changes when the handoff occurs. An ESMA is implemented for this purpose, which acts as an interface between the wireless subsystem and the wired ATM network and is responsible for the establishment and maintenance of WVC. UWB radio is used to provide communications in a dense multipath environment that are low power, high data rate, fade resistant, and relatively shadow free. The performance of such a radio was evaluated in terms of multiple-access capacity under ideal propagation conditions. The multiple-access capacity is shown to increase rapidly as additional required power increases. However, these improvements become gradual after a certain point and finally reach a limit which is referred to as maximum multiple-access capacity.

Extensive UWB-channel characterization experiments have been carried out to understand the indoor propagation channel. Robustness of the UWB signal to fades was quantified through cumulative distribution functions of the signal quality in various locations of the building. The results show that only a small fading margin is required to guarantee reliable communication. An infinite Rake-receiver concept was introduced, which serves as the best case (bench mark) for Rake-receiver design and permits estimation of the degradation due to the multipath channel. A typical ensemble of received signal correlations suggests that multipath places limits on the ability to extend PPM techniques to the M-ary case. These results must be taken into account when designing the data modulation schemes that provide robust, simple, high-rate capability in the presence of multipath.

## ACKNOWLEDGMENT

The authors would like to thank G. Chrisikos, R. J.-M. Cramer, J.-H. Ju, A. M. Petroff, L. W. Fullerton, and P. Withington for their encouragement and several stimulating and helpful discussions. They would also like to thank M. A. Barnes for his assistance with the initial propagation experiment.

## REFERENCES

- [1] V. O. K. Li and X. Qiu, "Personal communication systems (PCS)," *Proc. IEEE*, vol. 83, Sept. 1995, pp. 1210–1243.
- [2] A. S. Acampora and M. Naghshineh, "An architecture and methodology for mobile-executed handoff in cellular ATM networks," *IEEE J. Select. Areas Commun.*, vol. 12, pp. 1365–1375, Oct. 1994.
- [3] D. Raychaudhuri and N. D. Wilson, "ATM-based transport architecture for multiservices wireless personal communication networks," *IEEE J. Select. Areas Commun.*, vol. 12, pp. 1401–1414, Oct. 1994.
- [4] M. Schwartz, "Network management and control issues in multimedia wireless networks," *IEEE Personal Commun. Mag.*, pp. 8–16, June 1995.
- [5] R. A. Scholtz, "Multiple access with time-hopping impulse modulation," in *Proc. Military Comm. Conf.*, vol. 2, Oct. 1993, pp. 447–450.
- [6] M. Z. Win, R. A. Scholtz, and L. W. Fullerton, "Time-hopping SSMA techniques for impulse radio with an analog modulated data subcarrier," in *Proc. IEEE 4th Int. Symp. Spread Spectrum Techniques & Applications*, Mainz, Germany, Sept. 1996, pp. 359–364.
- [7] M. Z. Win and R. A. Scholtz, "Comparisons of analog and digital impulse radio for multiple-access communications," in *Proc. IEEE Int. Conf. Communication*, Montréal, Ont., Canada, June 1997, pp. 91–95.
- [8] S. S. Kolenchery, J. K. Townsend, J. A. Freebersyser, and G. Bilbro, "Performance of local power control in peer-to-peer impulse radio networks with bursty traffic," in *Proc. IEEE Global Telecommunications Conf.*, vol. 2, Phoenix, AZ, Nov. 1977, pp. 910–916.
- [9] S. S. Kolenchery, J. K. Townsend, and J. A. Freebersyser, "A novel impulse radio network for tactical military wireless communications," in *Proc. Military Communications Conf.*, vol. 1, Boston, MA, Oct. 1998, pp. 59–65.
- [10] M. K. Simon, J. K. Omura, R. A. Scholtz, and B. K. Levitt, *Spread Spectrum Communications Handbook*, revised ed. New York: McGraw-Hill, 1994.
- [11] R. L. Peterson, R. E. Ziemer, and D. E. Borth, *Introduction to Spread Spectrum Communications*, 1st ed. Englewood Cliffs, NJ: Prentice Hall, 1995.
- [12] M. Z. Win and R. A. Scholtz, "Characterization of ultra-wide bandwidth wireless indoor communications channel: A communications theoretic view," *IEEE Trans. Commun.*, submitted for publication.
- [13] ———, "Infinite Rake and selective Rake receivers for ultra-wide bandwidth transmissions in multipath environments," *IEEE Commun. Lett.*, 1999, to be published.
- [14] P. Agrawal, P. P. Mishra, and M. B. Srivastava, "Network architecture for mobile and wireless ATM," AT&T Bell Labs., Tech. Memo., 1995.
- [15] M. D. Prycker, *Asynchronous Transfer Mode: Solution for Broadband ISDN*, 2nd ed. Ellis Horwood, 1993.

- [16] J. M. Wozencraft and I. M. Jacobs, *Principles of Communication Engineering*, 1st ed. London: Wiley, 1965.
- [17] M. K. Simon, S. M. Hinedi, and W. C. Lindsey, *Digital Communication Techniques: Signal Design and Detection*, 1st ed. Englewood Cliffs, NJ: Prentice-Hall, 1995.
- [18] H. V. Poor, "Signal processing for wideband communications," *IEEE Inform. Soc. Newslett.*, June 1992.
- [19] S. Verdu, "Recent progress in multiuser detection," in *Multiple Access Communications: Foundations for Emerging Technologies*. Piscataway, NJ: IEEE Press, 1993, pp. 164-175.
- [20] A. Duel-Hallen, J. Holtzman, and Z. Zvonar, "Multiuser detection for CDMA systems," *IEEE Personal Commun.*, pp. 46-58, Apr. 1995.
- [21] C. L. Weber, G. K. Huth, and B. H. Batson, "Performance considerations of code division multiple-access systems," *IEEE Trans. Veh. Technol.*, vol. VT-30, pp. 3-9, Feb. 1981.
- [22] H. Hashemi, "The indoor radio propagation channel," *Proc. IEEE*, vol. 81, pp. 943-968, July 1993.
- [23] F. Ramírez-Mireles, M. Z. Win, and R. A. Scholtz, "Signal selection for the indoor wireless impulse radio channel," in *Proc. 47th Ann. Int. Vehicular Technology Conf.*, Phoenix, AZ, May 1997, pp. 2243-2247.



**Moe Z. Win** (S'85-M'87-SM'97) received the B.S. degree (magna cum laude) in electrical engineering from Texas A&M University, College Station, in 1987, the M.S. degrees in electrical engineering and applied mathematics from the University of Southern California (USC), Los Angeles, in 1989 and 1998, respectively, and the Ph.D. degree in electrical engineering, also from USC, in 1998.

In 1987, he joined the Jet Propulsion Laboratory (JPL), California Institute of Technology, Pasadena. From 1994 to 1997, he was a Research Assistant

with the Communication Sciences Institute, where he played a key role in the creation of the Ultra-Wideband Radio Laboratory (UltrLab) at USC. Since 1998, he has been with the Wireless Systems Research Department, AT&T Laboratories-Research, Red Bank, NJ, as a Senior Technical Staff Member. His main research interests are the application of communication, detection, and estimation theories to a variety of communications problems, including time-varying channels, diversity, equalization, synchronization, signal design, and ultrawide-bandwidth communication.

Dr. Win is a member of Eta Kappa Nu, Tau Beta Pi, Pi Mu Epsilon, Phi Theta Kappa, and Phi Kappa Phi. He was a University Undergraduate Fellow at Texas A&M University, where he received the Academic Excellence Award, among others. At USC, he was a Presidential Fellow, and he received the Outstanding Research Paper Award and the Phi Kappa Phi Student Recognition Award. He was a corecipient of the IEEE Communications Society's Best Student Paper Award at the 4th Annual IEEE NetWorld+Interop'97 Conference. He has been involved in chairing and organizing sessions in a number of IEEE conferences. He currently serves as a member of the Technical Program Committee for the IEEE Communication Theory Symposium's Globecom'99, the 1999 IEEE Wireless Communications and Networking Conference, and the 1999 IEEE 49th Annual International Vehicular Technology Conference. In addition, he serves as a member of the International Advisory Committee for the 1999 IEEE 50th International Vehicular Technology Conference. He is the current Editor for Equalization and Diversity for the IEEE TRANSACTIONS ON COMMUNICATIONS.

**Xiaoxin Qiu** (S'93-M'96) received the B.E. and M.E. degrees from Tsinghua University, China, in 1990 and 1991, respectively, and the Ph.D. degree from the University of Southern California, Los Angeles, in 1996.

She has since joined AT&T Labs-Research, Redbank, NJ, working in the Broadband Wireless Systems Research Department. Her research interests are in the areas of broadband wireless communications networks, personal communication systems, and multimedia communications.

Dr. Qiu was a corecipient of the IEEE Communications Society's Best Student Paper Award at the 4th Annual IEEE NetWorld+Interop'97 Conference.



**Robert A. Scholtz** (S'56-M'59-SM'73-F'80) was born in Lebanon, OH, in 1936. He received the Degree in Electrical Engineer (as a Sheffield Scholar) from the University of Cincinnati, OH, in 1958, the M.S. degree in electrical engineering (as a Hughes Masters Fellow) from the University of Southern California (USC), Los Angeles, in 1960, and the Ph.D. degree in electrical engineering (as a Hughes Doctoral Fellow) from Stanford University, Stanford, CA, in 1964.

He worked at Hughes Aircraft Company until 1978. In 1963, he joined the faculty at USC, where he is now Professor of Electrical Engineering. From 1984 to 1989, he served as Director of USC's Communication Sciences Institute. In 1996, he founded the Ultra-Wideband Radio Lab. He currently is Chairman of the Electrical Engineering-Systems Department, USC. He has consulted for the LinCom Corporation, Axionix, Inc., the Jet Propulsion Laboratory, Technology Group, TRW, Pulson Communications, and Qualcomm, as well as various government agencies. His research interests include communication theory, synchronization, signal design, coding, adaptive processing, and pseudonoise generation, and their application to communications and radar systems. He has coauthored *Spread Spectrum Communications* with M. K. Simon, J. K. Omura, and B. K. Levitt and *Basic Concepts in Information Theory and Coding* with S. W. Golomb and R. E. Peile.

In 1977, Dr. Scholtz was Finance Chairman for the IEEE National Telecommunications Conference, and in 1981, he was the Program Chairman for the International Symposium on Information Theory. He has held Board of Governors positions for the Information Theory Group and the Communications Society. In 1983, he received the Leonard G. Abraham Prize Paper Award. In 1984, he received the IEEE Donald G. Fink Prize Award. In 1992, he was a corecipient of the IEEE Signal Processing Society's Senior Award. During 1997, he was a corecipient of the Ellersick Award for the best unclassified paper at Milcom'97, and a paper he coauthored with students received the Best Student Paper Award from the NetWorld+Interop'97 Program Committee.



**Victor O. K. Li** (S'80-M'81-SM'86-F'92) was born in Hong Kong in 1954. He received the S.B., S.M., E.E., and Sc.D. degrees in electrical engineering and computer science from the Massachusetts Institute of Technology, Cambridge, MA, in 1977, 1979, 1980, and 1981, respectively.

In 1981, he joined the University of Southern California (USC), Los Angeles, CA as an Assistant Professor and became Professor of Electrical Engineering and the Director of the USC Communication Sciences Institute. Since 1997, he has been the Chair Professor of Information Engineering at the Department of Electrical and Electronic Engineering, University of Hong Kong and Managing Director of Versitech Ltd, the University of Hong Kong company. He has been a Distinguished Lecturer at the University of California, San Diego, the National Science Council of Taiwan, and the California Polytechnic Institute. His research interests are in information technologies, including high-speed communication networks, personal communication networks, and distributed multimedia systems. He is the convener of the Area of Excellence information Technology at the University of Hong Kong. He has published more than 200 technical articles and has lectured and consulted extensively around the world. He is also serving on various advisory boards of the Hong Kong government.

From 1983 to 1985, Dr. Li chaired the Los Angeles Chapter of the IEEE Information Theory Group, and from 1987 to 1989, he chaired the Computer Communications Technical Committee of the IEEE Communications Society. In addition, he was Chair of the Steering Committee of the International Conference on Computer Communications and Networks, from 1992 to 1997, General Chair of the 1st Annual IC3N, in 1992, Technical Program Chair of the Institution of Electrical Engineers (IEE) Personal Communication Services Symposium, in 1995, and Chair of the 4th IEEE Workshop on Computer Communications, in 1989. He has served as an Editor of *IEEE Network* and *Telecommunication Systems*, a Guest Editor of the IEEE JOURNAL ON SELECTED AREAS IN COMMUNICATIONS, and *Computer Networks and ISDN Systems*. He is now serving as an Editor of *ACM Wireless Networks* and IEEE COMMUNICATIONS SURVEY. He is a Fellow of the IAE and the HKIE and is a Distinguished Visitor of the IEEE Computer Society.