

(19) **United States**(12) **Patent Application Publication**
Che et al.(10) **Pub. No.: US 2002/0179885 A1**(43) **Pub. Date: Dec. 5, 2002**(54) **ORGANOMETALLIC LIGHT-EMITTING MATERIAL**(76) Inventors: **Chi-Ming Che**, Hong Kong (CN); **Wei Lu**, Hong Kong (CN); **Michael Chi-Wang Chan**, Hong Kong (CN)Correspondence Address:
PENNIE AND EDMONDS
1155 AVENUE OF THE AMERICAS
NEW YORK, NY 100362711(21) Appl. No.: **10/094,384**(22) Filed: **Mar. 8, 2002****Related U.S. Application Data**

(60) Provisional application No. 60/274,142, filed on Mar. 8, 2001.

Publication Classification(51) **Int. Cl.⁷** **C09K 11/06; C07D 213/02**(52) **U.S. Cl.** **252/301.16; 428/917; 313/504; 546/2**(57) **ABSTRACT**

Disclosed herein are novel light-emitting materials of Formula I and II below. These new complexes are synthesized and found to be sufficiently stable to allow sublimation and vacuum deposition. These new emitters are electrophosphorescent and can be used in organic light-emitting devices (OLEDs) for device elements capable of emitting light of color ranging from orange to red with high-efficiency and high-brightness.

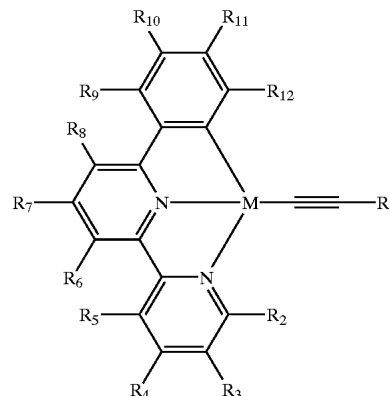

I

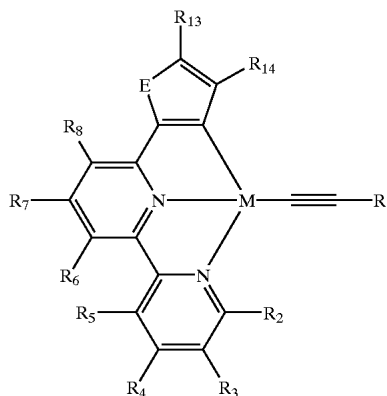

II

wherein E=Group 16 elements (including sulphur); M=Group 10 metal (including platinum); R₁-R₁₄ are each independently selected from the group consisting of hydrogen; halogen; alkyl; substituted alkyl; aryl; substituted aryl, with substituents selected from the group consisting of halogen, lower alkyl and recognized donor and acceptor groups. R₁ can also be selected from (C≡C)_nR₁₅, where (C≡C) represents a carbon-carbon triple bond (acetylide group), n is selected from 1 to 10, and R₁₅ is selected from alkyl, aryl, substituted aryl, and tri(alkyl)silyl.

Figure 1. General heterostructure of OLEDs.

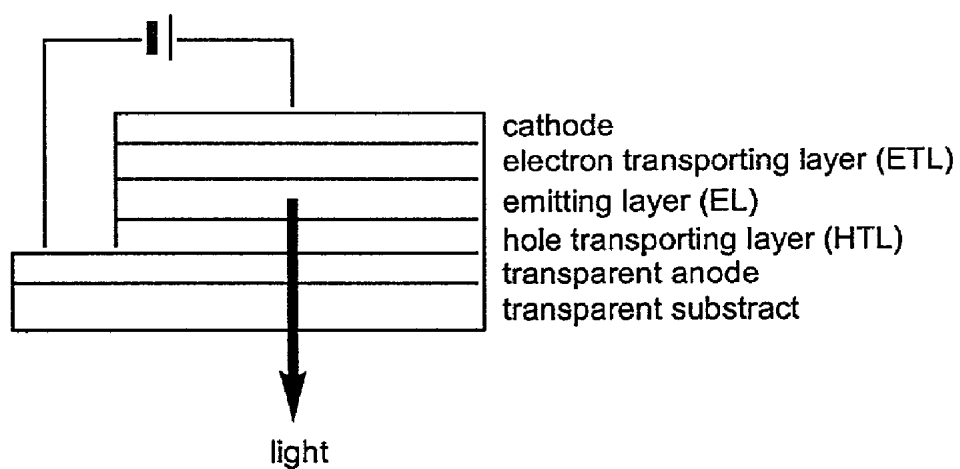

Figure 2. TGA curve of complex 2.

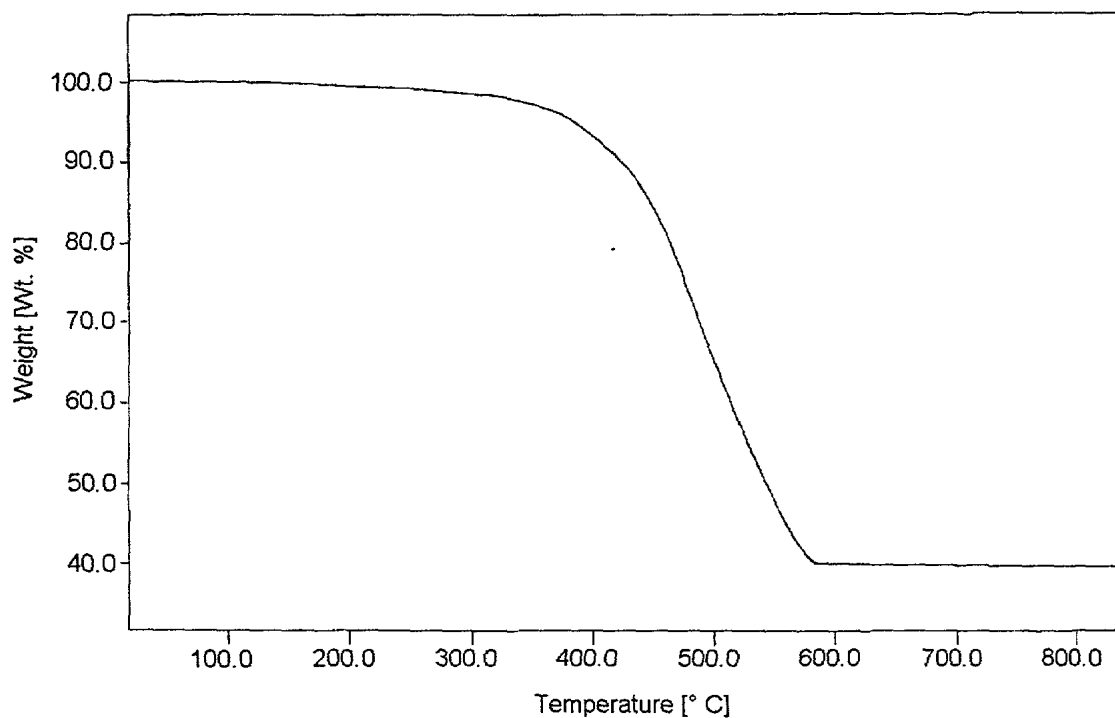

Figure 3. TGA curve of complex 15.

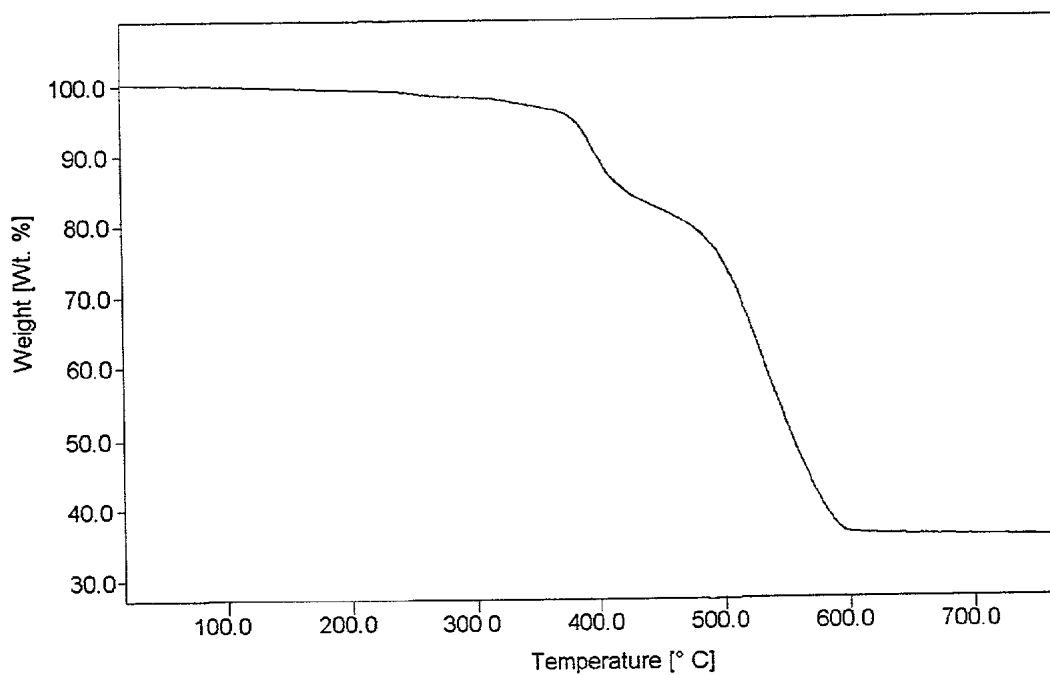

Figure 4. UV-vis absorption and emission spectra of complex 2 in dichloromethane at 298 K.

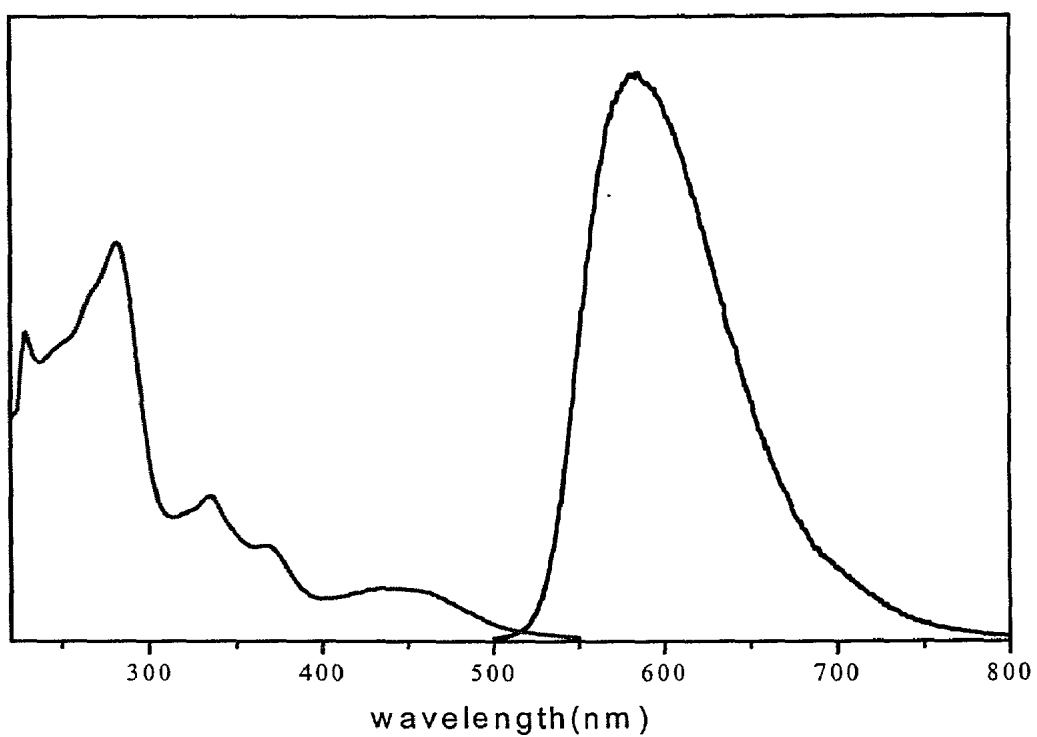

Figure 5. UV-vis absorption and emission spectra of complex 15 in dichloromethane at 298 K.

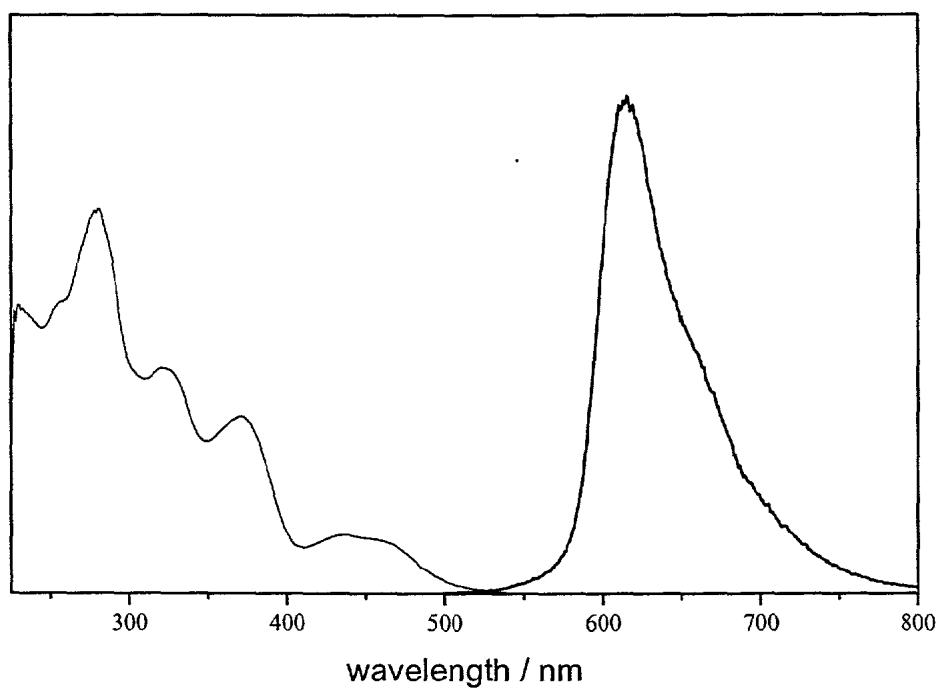

Figure 6. The heterostructure of OLEDs in present invention.

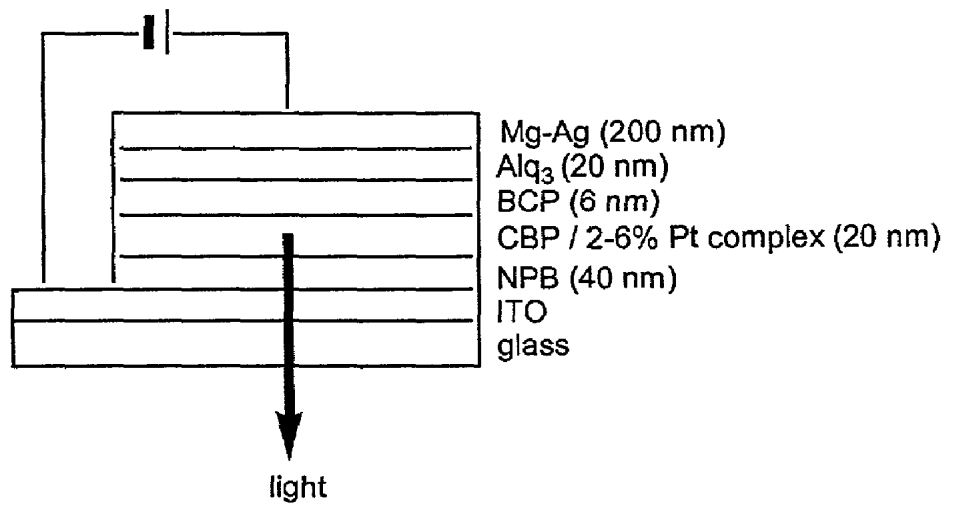

Figure 7. Electroluminescent spectrum, current-voltage (I-V) and luminance-voltage (B-V) curves and luminescent efficiency-current density curve of the device using complex 2 as emitter with a doping level of 2%.

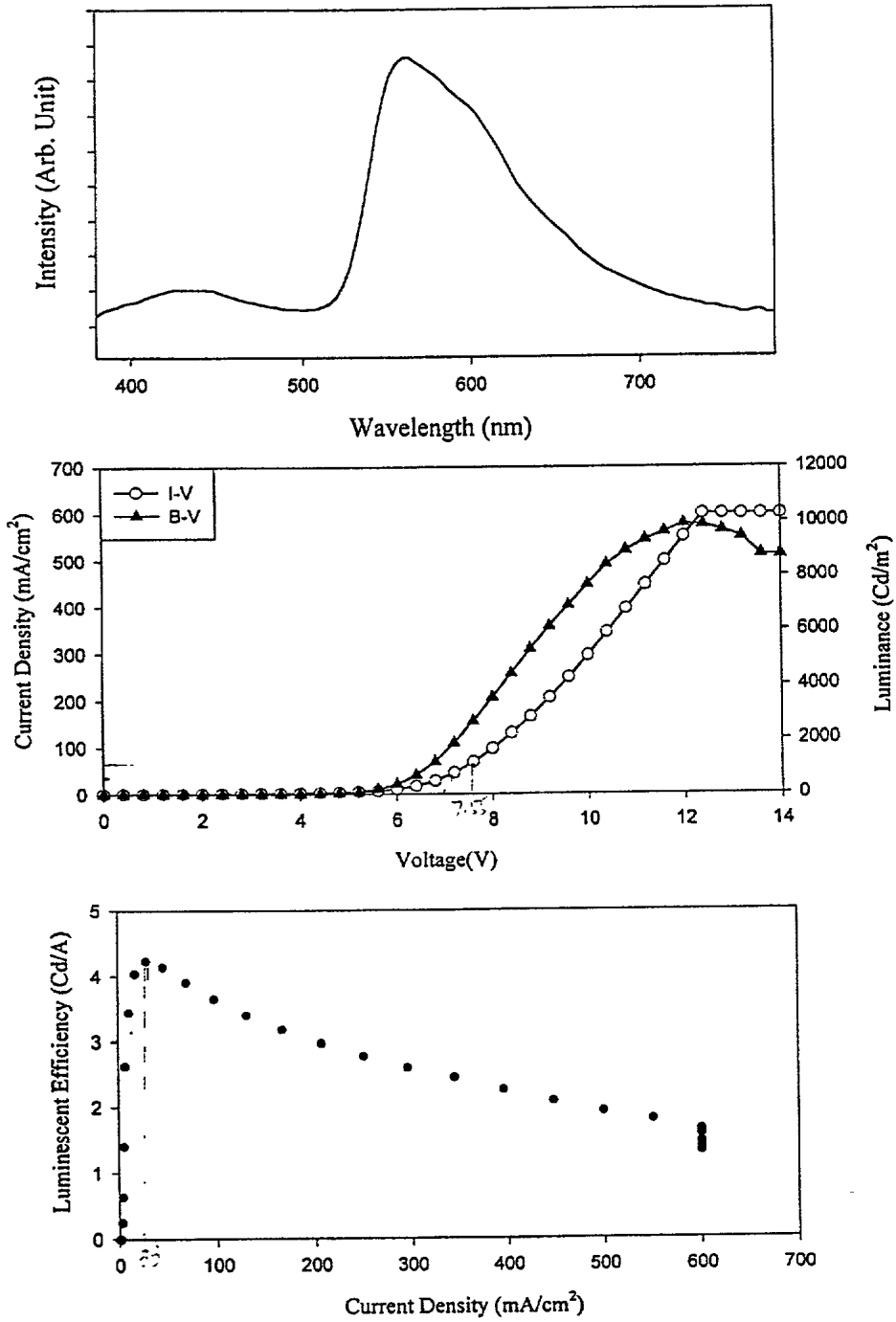

Figure 8. Electroluminescent spectrum, current-voltage (I-V) and luminance-voltage (B-V) curves and luminescent efficiency-current density curve of the device using complex 2 as emitter with a doping level of 4%.

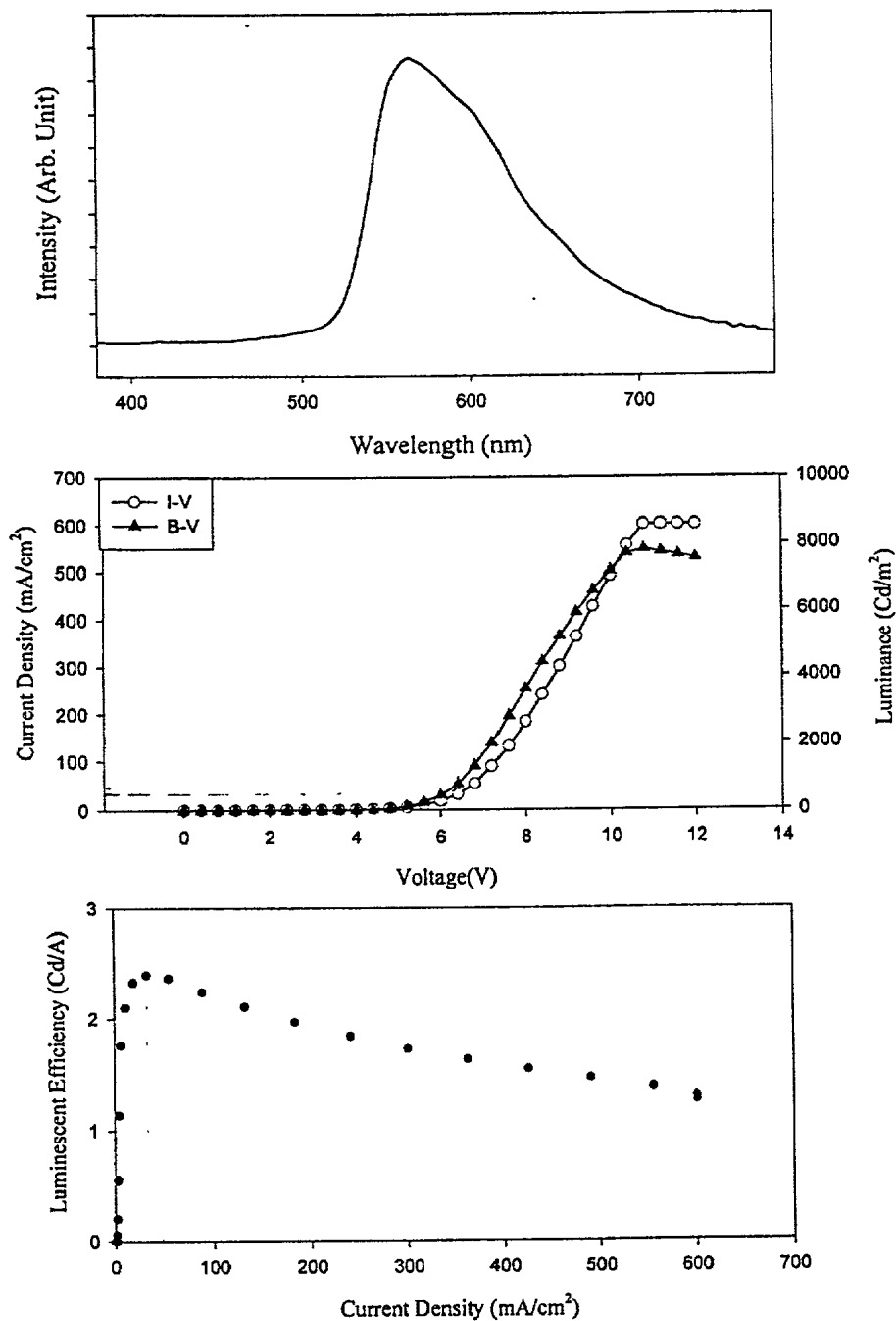

Figure 9. Electroluminescent spectrum, current-voltage (I-V) and luminance-voltage (B-V) curves and luminescent efficiency-current density curve of the device using complex 3 as emitter with a doping level of 4%.

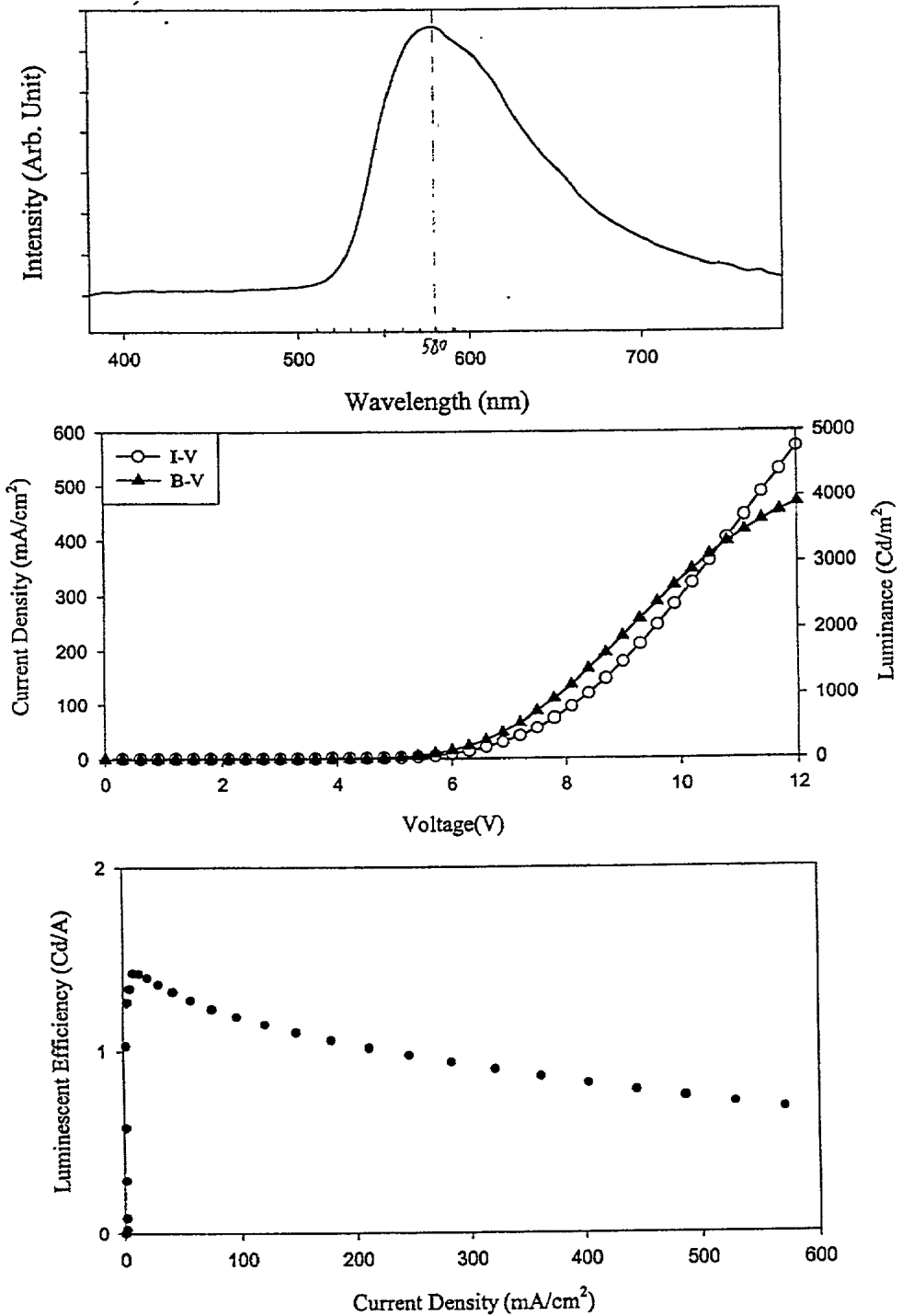
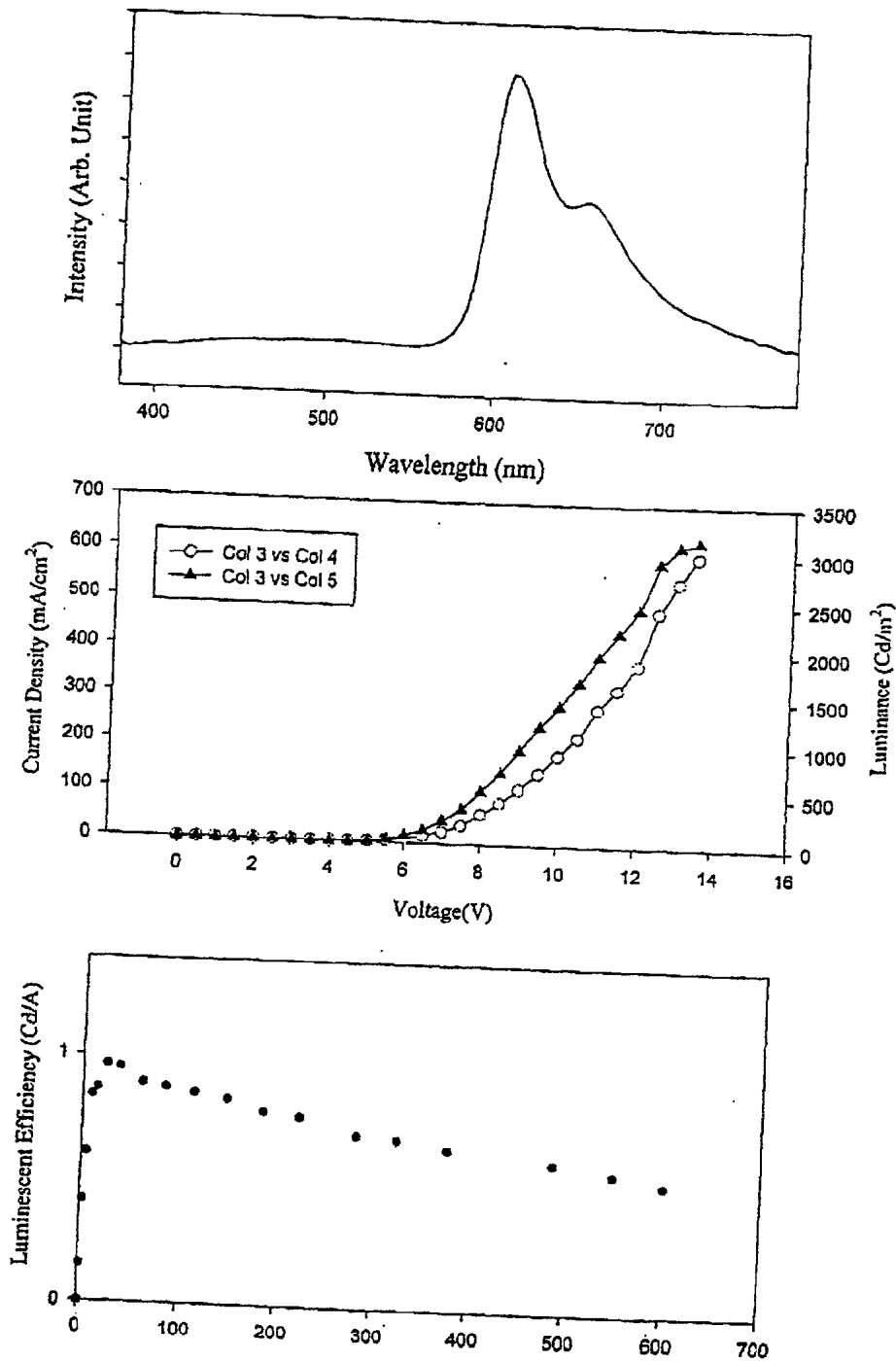

Figure 10. Electroluminescent spectrum, current-voltage (I-V) and luminance-voltage (B-V) curves and luminescent efficiency-current density curve of the device using complex 16 as emitter with a doping level of 4%.



ORGANOMETALLIC LIGHT-EMITTING MATERIAL

RELATED APPLICATION

[0001] The subject application claims the priority of U.S. provisional patent application No. 60/274,142, filed on Mar. 8, 2001.

FIELD OF THE INVENTION

[0002] This invention relates to light-emitting materials which are discrete organometallic molecules in nature, which can be deposited as a thin layer by vacuum deposition, and which can act as electrophosphorescent emitters in high-efficiency and high-brightness organic light-emitting devices (OLEDs).

BACKGROUND OF THE INVENTION

[0003] Tang and coworkers first reported on high-performance organic light-emitting devices (OLEDs) in 1987 (Tang, C. W.; et al. *Appl. Phys. Lett.* 51, 913 (1987)). Their discovery was based on employing a multilayer structure containing an emitting layer and a hole transport layer of a suitable organic substrate. Alq₃ (q=deprotonated 8-hydroxyquinoliny) was chosen as the emitting material and proven to be of high-performance because (1) it can form uniform thin films under 1000 Å using vacuum deposition, (2) it is a good charge carrier and (3) it exhibits strong fluorescence. Since then, there has been a flourish of research on OLEDs and materials used in these devices. Indeed, nearly every large chemical company in the world with optoelectronic interests has demonstrated some level of interest in OLEDs. Clearly, OLED technology is heading directly and rapidly into the marketplace, as suggested in a commercial report by Stanford Resources (by David E. Mentley, "The Market Potential for Organic Light-Emitting Diode Displays," *Commercial Report*, available at <http://www.stanfordresources.com>). The attractiveness of OLEDs as it challenges traditional technologies such as cathode ray tubes (CRTs), liquid crystal displays (LCDs) and plasma displays is based on many features and advantages, including:

- [0004] Low operating voltage,
- [0005] Thin, monolithic structure,
- [0006] Emits, rather than modulates light,
- [0007] Good luminous efficiency,
- [0008] Full color potential, and
- [0009] High contrast and resolution.

[0010] OLED is a device built with organic semiconductors from which visible light can be emitted upon electrical stimulation. The basic heterostructure of an OLED is described in FIG. 1.

[0011] The layers may be formed by evaporation, spin-casting or chemical self-assembly. The thickness ranges from a few monolayers (self-assembled films) to about 1000 to 2000 Å. Such devices whose structure is based on the use of layers of organic optoelectronic materials generally rely on a common mechanism leading to optical emission, namely, the radiative recombination of a trapped charge. Under a DC bias, electrons are injected from a cathode (usually Ca, Al, Mg—Ag) and holes are injected from an anode (usually transparent indium tin oxide (ITO)) into the organic materials, where they travel in the applied field across the electron transporting layer (ETL) and the hole transporting layer (HTL) respectively until they meet, pref-

erably on molecules in the emitting layer, and form a luminescent excited state (Frenkel exciton) which, under certain conditions, experiences radiative decay to give visible light. The electroluminescent material may be present in a separate emitting layer between the ETL and the HTL in what is referred as a multi-layer heterostructure. In some cases, buffer layers and/or other functional layers are also incorporated to improve the performance of the device. Alternatively, those OLEDs in which the electroluminescent emitters are the same materials that function either as the ETL or HTL are referred to as single-layer heterostructures.

[0012] In addition to emissive materials that are present as the predominant component in the charge carrier layers (HTL or ETL), other efficient luminescent material(s) may be present in relatively low concentrations as a dopant in these layers to realize color tuning and efficiency improvement. Whenever a dopant is present, the predominant material in the charge carrier layer may be referred to as a host. Ideally, materials that are present as hosts and dopant are matched so as to have a high level of energy transfer from the host to the dopant, and to yield emission with a relatively narrow band centered near selected spectral region with high-efficiency and high-brightness.

[0013] While fluorescent emitters with high luminescence efficiencies have been extensively applied as dopant in OLEDs, phosphorescent emitters have been neglected in this domain. However, the quantum efficiency of an electrofluorescence device is limited by the low theoretical ratio of singlet exciton (25%) compared to triplet exciton (75%) upon electron-hole recombination from electrical excitation. In contrast, when phosphorescent emitters are employed, the potentially high energy/electron transfer from the hosts to the phosphorescent emitters may result in significantly superior electroluminescent efficiency (Baldo, M. A.; et al. *Nature* 395, 151 (1998) and Ma, Y. G.; et al. *Synth. Met.* 94, 245 (1998)). Several phosphorescent OLED systems have been fabricated and have indeed proven to be of relative high-efficiency and high-brightness.

[0014] It is desirable for OLEDs to be fabricated using materials that provide electrophosphorescent emission corresponding to one of the three primary colors, i. e., red, green and blue so that they may be used as a component layer in full-color display devices. It is also desirable that such materials are capable of being deposited as thin films using vacuum deposition techniques, which has been prove to be a common method for high-performance OLED fabrication, so that the thickness of the emitting layer can be precisely controlled.

[0015] Presently, the highest efficiencies and brightness have been obtained with green electrophosphorescent devices (15.4±0.2% for external quantum efficiency and almost 100% for internal efficiency, 10⁵ Cd/m² for maximum luminance) using Ir(ppy)₃ (Ppy=deprotonated 2-phenylpyridine) as emitter (Adachi, C.; et al. *Appl. Phys. Lett.* 77, 904 (2000)). An OLED emitting saturated red light based on the electrophosphorescent dopant Pt(OEP) (H₂OEP=octaethylporphyrin) has also been published and patented (Burrows, P.; et al. U.S. Pat. No. 6,048,630) but the maximum luminance is only around 500 Cd m⁻². A relevant patent is the use of the cyclometalated platinum(II) complex Pt(thpy)₂ (thpy=deprotonated 2-(2-thioenyl)pyridine) as dopant and PVK (poly(N-vinyl)carbazole) as host in a orange OLED (Lamansky, S.; et al. WO Pat. No. 00/57676). However, the Pt(II) complex used by the inventors was not stable for sublimation or vacuum deposition, thus a spin-casting method was applied, which led to higher driving voltages, quantum efficiency of 0.11% and luminance of 100 Cd/m² were obtained at 22 V.

SUMMARY OF THE INVENTION

[0016] The present invention is directed to novel organo-metallic light-emitting materials which may be used as electrophosphorescent emitters or dopants in high-performance OLEDs. In particular, the present invention is directed to the design, synthesis, properties and applications of a family of phosphorescent emitters which, when added in effective amounts to suitable host material, including emissive compounds, electron transporting compounds and hole transporting compounds, tune the color of emission in the near-red range and enhance the device efficiency and brightness. Furthermore, the thermal stability of these phosphorescent emitters in the present invention are sufficient to allow sublimation, so that they may be readily incorporated into devices using vacuum deposition techniques, and hence high-performance electrophosphorescent devices prepared entirely from vacuum-deposited materials may be realized.

[0017] The family of electrophosphorescent emitters for use in the present invention are acetylide (alkynyl) complexes of the Group 10 metals, including platinum, with chemical structures of either Formula I or II:

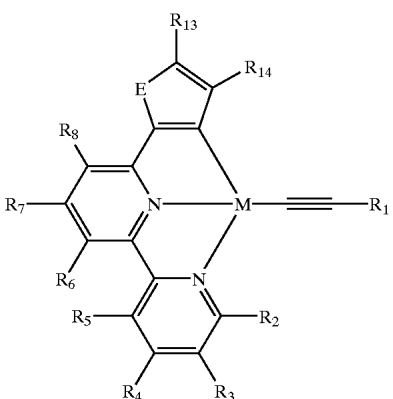
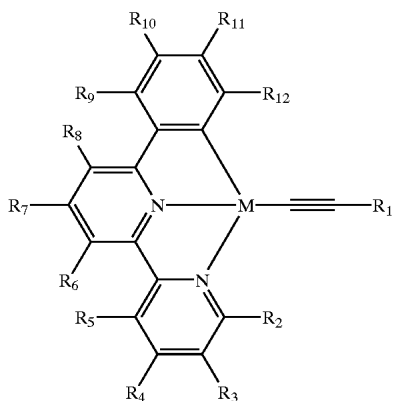

[0018] wherein E=Group 16 elements (including sulphur); M=Group 10 metal (including platinum); R₁-R₁₄ are each independently selected from the group consisting of hydrogen; halogen; alkyl; substituted alkyl; aryl; substituted aryl, with substituents selected from the group consisting of halogen, lower alkyl and recognized donor and acceptor groups. R₁ can also be selected from (C≡C)_nR₁₅, where (C≡C) represents a carbon-carbon triple bond (acetylide group), n is selected from 1 to 10, and R₁₅ is selected from alkyl, aryl, substituted aryl, and tri(alkyl)silyl. Group 16 elements are also known as the Group VIA elements. Group 10 elements also belong to Group VIII B.

[0019] As established by thermogravimetric analysis, some of these complexes are thermally stable up to ~400° C. These complexes are good phosphorescent emitters and give strong orange to red emissions (λ_{max} 550-630 nm) in fluid solutions by photo excitation and in OLEDs by electrical stimulation.

[0020] Generally, the present invention is directed to the syntheses and OLED applications of the family of electrophosphorescent emitters defined by Formula I and II. Our claims include the synthetic method for these novel complexes as well as their use as light-emitting material. These OLED applications include OLEDs wherein these complexes are incorporated as components either by vacuum deposition, spin-casting or other device fabrication methods.

[0021] In the present invention, the light-emitting material for use as an emitter or dopant in an OLED can comprise one or more metal-acetylide (metal-alkynyl) groups. In alternative, the light-emitting material for use as an emitter or dopant in an OLED comprises one or more platinum-acetylide (platinum-alkynyl) groups. In one embodiment, the light-emitting material for use as an emitter or dopant in an OLED can comprise a platinum atom coordinated by a tridentate ligand using one carbon and two nitrogen atoms. In another embodiment, the light-emitting material for use as an emitter or dopant in an OLED comprising a platinum atom coordinated by a tridentate ligand bearing a deprotonated phenyl carbonion and 2,2'-bipyridine.

[0022] In an exemplary embodiment, the light-emitting material for use as an emitter or dopant in an OLED can have a chemical structure represented by either Formula I or II;

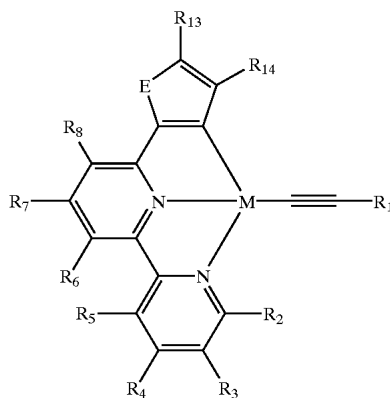
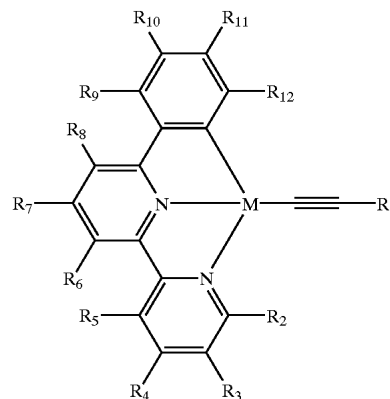

[0023] wherein E=Group 16 elements (including sulphur); M=Group 10 metal (including platinum); R₁-R₁₄ are each independently selected from the group consisting of hydrogen; halogen; alkyl; substituted alkyl; aryl; substituted aryl, with substituents selected from the group consisting of halogen, lower alkyl and recognized donor and acceptor groups. R₁ can also be selected from (C≡C)_nR₁₅, where (C≡C) represents a carbon-carbon triple bond (acetylide group), n is selected from 1 to 10, and R₁₅ is selected from alkyl, aryl, substituted aryl, and tri(alkyl)silyl.

[0024] In one embodiment, the light-emitting material can be deposited as a thin layer by sublimation or vacuum deposition. In another embodiment, the light-emitting material can be fabricated into OLEDs using spin-coating or other methods.

BRIEF DESCRIPTION OF THE FIGURES

[0025] FIG. 1. General heterostructure of OLEDs.

[0026] FIG. 2. TGA curve of complex 2.

[0027] FIG. 3. TGA curve of complex 15.

[0028] FIG. 4. UV-vis absorption and emission spectra of complex 2 in CH₂Cl₂ at 298 K.

[0029] FIG. 5. UV-vis absorption and emission spectra of complex 15 in CH₂Cl₂ at 298 K.

[0030] FIG. 6. The heterostructure of OLEDs in present invention.

[0031] FIG. 7. Electroluminescent spectrum, current-voltage (I-V) and luminance-voltage (B-V) curves and luminescent efficiency-current density curve of the device using complex 2 as emitter with a doping level of 2%.

[0032] FIG. 8. Electroluminescent spectrum, current-voltage (I-V) and luminance-voltage (B-V) curves and luminescent efficiency-current density curve of the device using complex 2 as emitter with a doping level of 4%.

[0033] FIG. 9. Electroluminescent spectrum, current-voltage (I-V) and luminance-voltage (B-V) curves and luminescent efficiency-current density curve of the device using complex 3 as emitter with a doping level of 4%.

[0034] FIG. 10. Electroluminescent spectrum, current-voltage (I-V) and luminance-voltage (B-V) curves and luminescent efficiency-current density curve of the device using complex 16 as emitter with a doping level of 4%.

DETAILED DESCRIPTION OF THE INVENTION

[0035] The present invention is generally directed to syntheses and properties of a family of organometallic light-emitting materials and their applications in high-performance OLEDs. These novel complexes possess several chemical and structural characteristics as follows:

[0036] Cyclometalated diimine complexes of Group 10 metals, including platinum,

[0037] Neutral molecules,

[0038] Square planar coordination environment around metal,

[0039] Tridentate ligands defined as (C[∧] N[∧] AN) occupy three of the coordination sites, and

[0040] Acetylide (alkynyl) group occupies the fourth coordination site.

[0041] The type of [(C[∧]N[∧]N)Pt(II)] complexes which combine the structural and spectroscopic characteristics of both diimine and cyclometalated Pt(II) complexes have been reported ((a) Lai, S. W.; et al. *Inorg. Chem.* 38, 4046 (1999). (b) Cheung, T. C.; et al. *J. Chem. Soc., Dalton Trans.* 1645 (1996). (c) Lai, S. W.; et al. *Organometallics* 18, 3327 (1999). (d) Yip, J. H. K.; et al. *Inorg. Chem.* 39, 3537 (2000). (e) Neve, F.; et al. *Inorg. Chem.* 36, 6150 (1997)). The results demonstrated that these complexes are good room-temperature phosphorescent emitters both in solid state and in fluid solution. The relatively long-lived emissions occurring in the range of λ_{max} 530-800 nm have been assigned to triplet metal-to-ligand charge transfer (³MLCT) or metal-metal-to-ligand charge transfer (³MMLCT) excited states.

[0042] The present invention will now be described in detail for specific preferred embodiment of the invention, it being understood that these embodiments are intended only as illustrative examples and the invention is not to be limited thereto.

[0043] Syntheses of the Complexes

[0044] We have synthesized a number of the tridentate cyclometalated Pt(II) arylacetylides

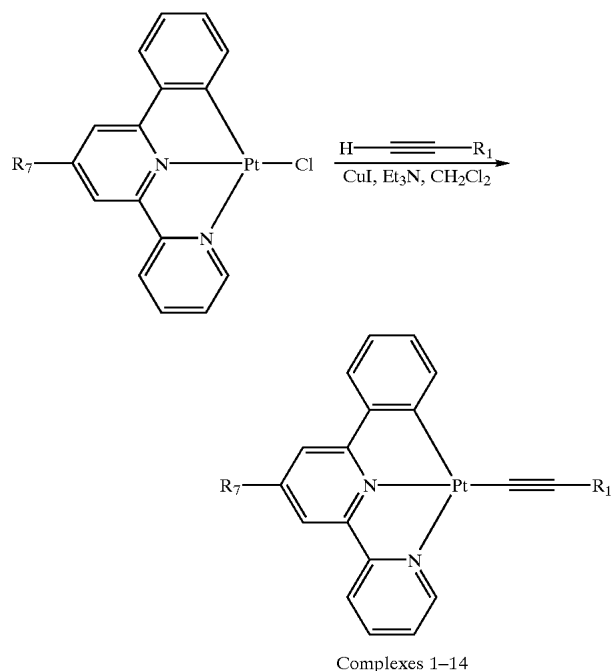

[0045] with different substituents on the aryl rings which are depicted in either Formula I or II. The synthetic methods are shown in Scheme 1:

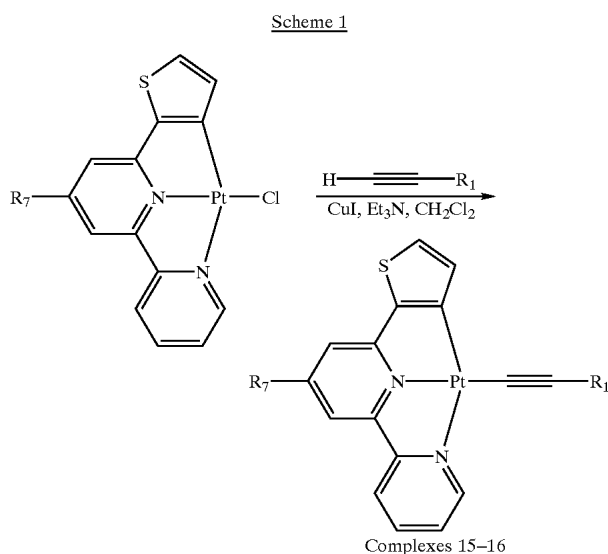

[0046] The tridentate (C[^]N[^]N) ligands were prepared according to Kröhnke's method (Kröhnke, F. *Synthesis* 1 (1976)). The various acetylenes were prepared with Sonogashira's method (Takahashi, S. et al. *Synthesis* 627 (1980)). The Cl-ligated precursors [(C[^]N[^]N)PtCl] were prepared under Constable's condition (Constable, E. C.; et al. *J. Chem. Soc., Dalton Trans.* 2251 (1992) and 443 (1990)). The desired complexes were synthesized by Cu(I)-organic amine-catalyzed reactions. For example, to a mixture of [(C[^]N[^]N)PtCl] (0.33 mmol), terminal acetylene (1 mmol) and Et₃N (3 mL) in degassed CH₂Cl₂ (30 mL) solution was added CuI (5 mg). The suspension was stirred for 12 h under a nitrogen atmosphere at room temperature and in the absence of light. The resultant mixture was rotatory-evaporated to dryness. The crude product was purified by flash chromatography (neutral Al₂O₃, CH₂Cl₂ as eluent) and/or recrystallization from dichloromethane/diethyl ether. Examples are listed in Table I but not limited by them:

TABLE I

Complex	Chemical Structure	Characterization Data
1		orange crystalline powder. FAB MS: 524 (M ⁺ + H), 523 (M ⁺); ¹ H NMR (300 MHz, CDCl ₃ , 22° C., TMS): δ 9.02 (d, 1H, J = 5.3 Hz), 7.94 (t, 1H, J = 7.8 Hz), 7.87 (d, 1H, J = 7.4 Hz), 7.82 (d, 1H, J = 8.0 Hz), 7.68 (t, 1H, J 8.0 Hz), 7.51 (d, 1H, J = 7.7 Hz), 7.45 (t, 1H, J = 7.5 Hz), 7.41 (d, 1H, J = 8.1 Hz), 7.21 (d, 1H, J = 7.2 Hz), 7.15 (t, 1H, J = 7.4 Hz), 7.02 (t, 1H, J = 7.5 Hz), 0.27 (s, 9H).
2		orange crystalline powder. FAB MS: 528 (M ⁺ + H), 527 (M ⁺); ¹ H NMR (300 MHz, CDCl ₃ , 22° C., TMS): δ = 9.15 (d, 1H, J = 4.3 Hz), 7.97 (m, 2H), 7.85 (d, 1H, J = 8.1 Hz), 7.75 (t, 1H, J = 8.0 Hz), 7.55 (m, 3H), 7.48 (m, 2H), 7.31 (m, 3H), 7.17 (t, 2H, J = 7.0 Hz), 7.05 (t, 1H, J = 7.4 Hz).

TABLE I-continued

Complex	Chemical Structure	Characterization Data
3		orange-red crystalline powder. FAB MS: 542 ($M^+ + H$), 541 (M^+); 1H NMR (300 MHz, $CDCl_3$, 22° C., TMS): δ = 9.07 (d, 1H, J = 4.3 Hz), 7.92 (m, 2H), 7.82 (d, 1H, J = 7.8 Hz), 7.69 (t, 1H, J = 8.0 Hz), 7.53 (d, 1H, J = 7.3 Hz), 7.43 (m, 4H), 7.27 (d, 1H, J = 6.3 Hz), 7.15 (t, 1H, J = 7.3 Hz), 7.10 (d, 2H, J = 7.9 Hz), 7.02 (t, 1H, J = 7.5 Hz), 2.35 (s, 3H).
4		red crystalline powder. FAB MS: 558 ($M^+ + H$), 557 (M^+); 1H NMR (300 MHz, $CDCl_3$, 22° C., TMS): δ = 9.12 (d, 1H, J = 5.2 Hz), 7.95 (m, 2H), 7.83 (d, 1H, J = 7.9 Hz), 7.72 (t, 1H, J = 8.0 Hz), 7.50 (m, 3H), 7.49 (d, 2H, J = 8.8 Hz), 7.30 (d, 1H, J = 6.6 Hz), 7.16 (t, 1H, J = 7.4 Hz), 7.03 (t, 2H, J = 7.4 Hz), 6.84 (d, 2H, J = 8.8 Hz), 3.82 (s, 3H).
5		orange-red crystalline powder. FAB MS: 562 (M^+); 1H NMR (300 MHz, $CDCl_3$, 22° C., TMS): δ = 9.05 (d, 1H, J = 5.1 Hz), 7.94 (t, 1H, J = 7.8 Hz), 7.87 (d, 1H, J = 7.5 Hz), 7.81 (d, 1H, J = 7.9 Hz), 7.71 (t, 1H, J = 8.0 Hz), 7.52 (d, 1H, J = 7.7 Hz), 7.46 (m, 2H), 7.45 (d, 1H, J = 8.5 Hz), 7.27 (d, 1H, J = 4.2 Hz), 7.23 (d, 2H, J = 8.8 Hz), 7.15 (t, 1H, J = 7.4 Hz), 7.03 (t, 1H, J = 7.4 Hz).
6		black-red crystals. FAB MS: 546 ($M^+ + H$), 545 (M^+); 1H NMR (300 MHz, $CDCl_3$, 22° C., TMS): δ = 9.12 (d, 1H, J = 5.2 Hz), 7.97 (t, 1H, J = 7.9 Hz), 7.92 (d, 1H, J = 7.6 Hz), 7.84 (d, 1H, J = 8.0 Hz), 7.74 (t, 1H, J = 8.0 Hz), 7.56–7.47 (m, 5H), 7.32 (d, 1H, J = 7.6 Hz), 7.17 (t, 1H, J = 7.4 Hz), 7.05 (t, 1H, J = 7.5 Hz), 6.98 (pseudo-t, 2H, J = 7.7 Hz).

TABLE I-continued

Complex	Chemical Structure	Characterization Data
7		orange crystalline powder. FAB MS: 573 ($M^+ + H$), 572 (M^+); 1H NMR (300 MHz, d_6 -DMSO, 22° C., TMS): δ = 8.98 (d, 1H, J = 4.5 Hz), 8.48 (d, 1H, J = 8.0 Hz), 8.32 (t, 1H, J = 8.0 Hz), 8.20 (d, 1H, J = 7.4 Hz), 8.14 (d, 2H, J = 8.8 Hz), 8.11 (t, 1H, J = 8.0 Hz), 7.99 (d, 1H, J = 7.8 Hz), 7.83 (t, 1H, J = 7.5 Hz), 7.68 (d, 1H, J = 7.3 Hz), 7.62 (d, 1H, J = 7.4 Hz), 7.58 (d, 2H, J = 8.9 Hz), 7.11 (t, 1H, J = 7.3 Hz), 7.05 (t, 1H, J = 7.3 Hz).
8		brown crystals. FAB MS: 534 ($M^+ + H$), 533 (M^+); 1H NMR (300 MHz, d_6 -DMSO, 22° C., TMS): δ = 8.94 (d, 1H, J = 5.1 Hz), 8.46 (d, 1H, J = 7.9 Hz), 8.30 (t, 1H, J = 7.8 Hz), 8.17 (d, 1H, J = 7.6 Hz), 8.08 (t, 2H, J = 7.9 Hz), 7.96 (d, 1H, J = 7.9 Hz), 7.84 (t, 1H, J = 6.4 Hz), 7.66 (d, 1H, J = 6.2 Hz), 7.59 (d, 1H, J = 7.4 Hz), 7.21 (d, 1H, J = 4.9 Hz), 7.10 (t, 1H, J = 7.3 Hz), 7.03 (t, 1H, J = 7.3 Hz), 6.97–6.92 (m, 2H).
9		orange crystalline powder. FAB MS: 604 ($M^+ + H$), 603 (M^+); 1H NMR (300 MHz, d_6 -DMSO, 22° C., TMS): δ = 8.99 (d, 1H, J = 4.8 Hz), 8.68 (d, 1H, J = 8.0 Hz), 8.50 (s, 1H), 8.32 (t, 1H, J = 7.7 Hz), 8.24 (s, 1H), 8.08–8.05 (m, 2H), 7.84–7.78 (m, 2H), 7.70 (d, 1H, J = 7.9 Hz), 7.61–7.55 (m, 3H), 7.36 (d, 1H, J = 7.2 Hz), 7.26 (t, 1H, J = 7.6 Hz), 7.17–7.01 (m, 3H).
10		orange crystalline powder. FAB MS: 614 ($M^+ + H$), 613 (M^+); 1H NMR (300 MHz, $CDCl_3$, 22° C., TMS): δ = 8.90 (d, 1H, J = 5.4 Hz), 7.99 (t, 1H, J = 7.5 Hz), 7.90 (d, 1H, J = 8.0 Hz), 7.76 (d, 1H, J = 6.2 Hz), 7.60–7.57 (m, 3H), 7.40–7.31 (m, 4H), 7.26 (d, 1H, J = 6.1 Hz), 7.03–6.98 (m, 2H), 2.48 (s, 3H), 0.33 (s, 9H).

TABLE I-continued

Complex	Chemical Structure	Characterization Data
11		orange crystalline powder. FAB MS: 618 ($M^+ + H$), 617 (M^+); 1H NMR (300 MHz, d_6 -DMSO, 22° C., TMS): δ = 9.04 (d, 1H, J = 5.0 Hz), 8.69 (d, 1H, J = 7.9 Hz), 8.50 (s, 1H), 8.34 (t, 1H, J = 7.7 Hz), 8.24 (s, 1H), 8.01 (d, 2H, J = 7.5 Hz), 7.84–7.74 (m, 3H), 7.40–7.30 (m, 4H), 7.30 (t, 2H, J = 7.5 Hz), 7.18–7.06 (m, 3H), 2.40 (s, 3H).
12		red crystals. FAB MS: 632 ($M^+ + H$), 631 (M^+); 1H NMR (300 MHz, d_6 -DMSO, 22° C., TMS): δ = 9.05 (d, 1H, J = 4.9 Hz), 8.56 (d, 1H, J = 8.0 Hz), 8.34 (s, 1H), 8.20 (t, 1H, J = 7.9 Hz), 8.00 (s, 1H), 7.85 (d, 2H, J = 8.1 Hz), 7.76–7.68 (m, 2H), 7.62 (d, 1H, J = 8.2 Hz), 7.31 (d, 2H, J = 8.1 Hz), 7.25 (d, 2H, J = 8.0 Hz), 7.07–6.97 (m, 4H), 2.39 (s, 3H), 2.28 (s, 3H).
13		orange crystalline powder. FAB MS: 634 ($M^+ + H$), 633 (M^+); 1H NMR (300 MHz, d_6 -DMSO, 22° C., TMS): δ = 9.00 (d, 1H, J = 4.9 Hz), 8.69 (d, 1H, J = 8.1 Hz), 8.48 (s, 1H), 8.32 (t, 1H, J = 7.9 Hz), 8.26 (s, 1H), 8.08 (d, 2H, J = 8.8 Hz), 8.06–7.81 (m, 2H), 7.72 (d, 1H, J = 7.1 Hz), 7.35 (d, 2H, 17.1 Hz), 7.26 (t, 2H, J = 7.6 Hz), 7.16–7.04 (m, 5H), 3.84 (s, 3H).

TABLE I-continued

Complex	Chemical Structure	Characterization Data
14		brown crystalline powder. FAB MS: 638 (M^+); 1H NMR (300 MHz, d_6 -DMSO, 22° C., TMS): δ = 8.99 (broad, 1H), 8.64 (d, 1H, J = 7.7 Hz), 8.47 (s, 1H), 8.31 (t, 1H, J = 7.6 Hz), 8.21 (s, 1H), 8.09 (d, 2H, J = 8.1 Hz), 7.82–7.68 (m, 3H), 7.62 (d, 2H, J = 8.2 Hz), 7.38 (d, 2H, J = 7.2 Hz), 7.28 (t, 2H, J = 7.3 Hz), 7.18 (t, 1H, J = 7.0 Hz), 7.08–7.03 (m, 2H).
15		brown needles. FAB MS: 534 ($M^+ + H$), 533 (M^+); 1H NMR (300 MHz, d_6 -DMSO, 22° C., TMS): δ = 9.01 (d, 1H, J = 5.0 Hz), 8.46 (d, 1H, J = 8.2 Hz), 8.35 (t, 1H, J = 7.9 Hz), 8.02 (d, 1H, J = 7.6 Hz), 7.96 (t, 1H, J = 7.8 Hz), 7.85 (t, 1H, J = 6.4 Hz), 7.72 (d, 1H, J = 4.9 Hz), 7.56 (d, 1H, J = 7.3 Hz), 7.38 (d, 2H, J = 7.0 Hz), 7.29 (t, 2H, J = 7.6 Hz), 7.17 (t, 1H, J = 7.3 Hz), 7.11 (d, 1H, J = 4.6 Hz).
16		brown needles. FAB MS: 548 ($M^+ + H$), 547 (M^+); 1H NMR (300 MHz, d_6 -DMSO, 22° C., TMS): δ = 9.03 (d, 1H, J = 5.2 Hz), 8.47 (d, 1H, J = 8.2 Hz), 8.34 (t, 1H, J = 7.2 Hz), 8.02 (d, 1H, J = 7.9 Hz), 7.96 (t, 1H, J = 7.7 Hz), 7.86 (t, 1H, J = 6.3 Hz), 7.73 (d, 1H, 14.9 Hz), 7.56 (d, 1H, J = 7.6 Hz), 7.26 (d, 2H, J = 7.9 Hz), 7.13 (d, 1H, J = 4.6 Hz), 7.11 (d, 2H, J = 7.9 Hz), 2.30 (s, 3H).

[0047] Thermal-stability of the Complexes

[0048] Ideally, a low molecular weight component to be used in OLEDs should be sublimable and stable at standard deposition conditions. Importantly, many of the complexes in the present invention are thermally stable up to $\sim 400^\circ$ C. and decompose to give metallic platinum only at temperature above 420° C. (see TGA curves for complexes **2** and **15** in FIGS. 2 and 3 respectively).

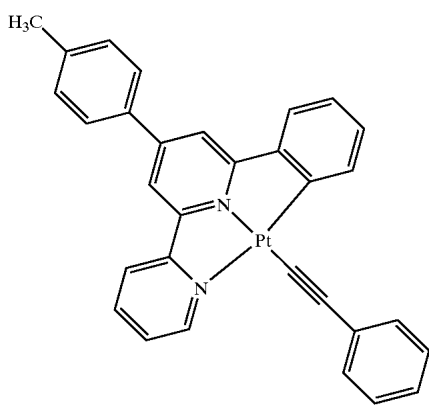
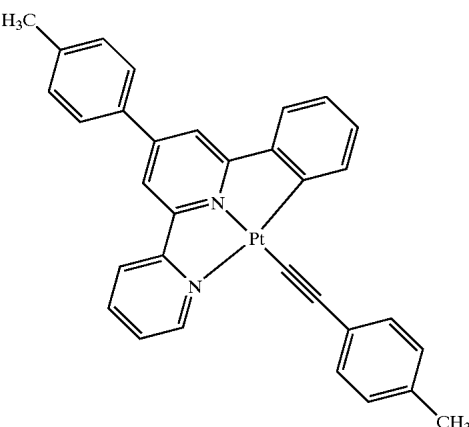
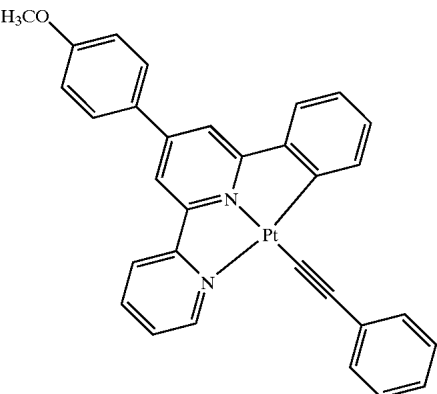
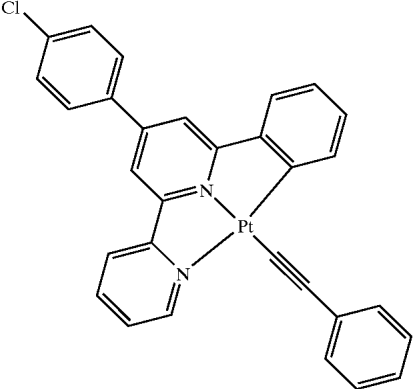
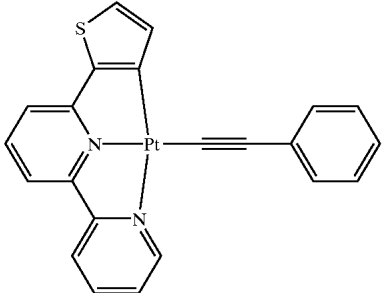
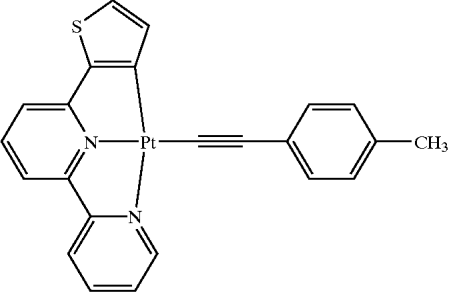
[0049] The observed thermal stability of these complexes described in the present invention which contain a tridentate cyclometalating ligand, contrasts sharply with the bidentate

Pt(thpy)₂ emitter described by Lamasky et al. which are unstable upon sublimation.

[0050] Spectroscopic Properties of the Complexes

[0051] In present invention, the ligation of an acetylide group to the (C[^]N[^]N)Pt(II) moiety neutralizes the positive charge centered on Pt(II), enhances the stability of these complexes, and moreover, shifts the ³MLCT emission bathochromically. The family of complexes depicted by Formula I and II display strong orange to red photoluminescence in fluid solution. Examples of characteristic absorption and emission band of these emitters in present invention are summarized in Table II:

TABLE II

Complex (see Table I)	Absorption MLCT Band/nm ($\epsilon/\text{mol dm}^{-1} \text{cm}^{-1}$)	Emission $\lambda_{\text{max}}/\text{nm}$ ($\tau_0/\mu\text{s}; \phi_0$)
1	427 (5490), 450 (sh, 4920), 505 (sh, 430)	570 (0.31; 0.041)
2	434 (5180), 455 (4940), 510 (sh, 470)	582 (0.39; 0.037)
3	440 (5090), 465 (sh, 4950), 515 (sh, 1190)	600 (0.17; 0.019)
4	440 (4200), 460 (sh, 4220), 520 (sh, 1570)	630
5	432 (8670), 455 (sh, 8310), 515 (sh, 720)	598 (0.53; 0.076)
6	433 (4880), 453 (sh, 4760), 515 (sh, 640)	585 (0.33; 0.033)
7	415 (sh, 12930), 510 (sh, 540)	560 (0.93; 0.077)
15	436 (4970), 460 (sh, 4490), 515 (sh, 460)	615 (1.02; 0.029), 660 (sh)
16	442 (5010), 465 (sh, 4800), 520 (sh, 670)	616 (0.91; 0.025), 660 (sh)

[0052] Notice that all the data were collected with degassed CH_2Cl_2 solution at 298 K. Exemplified absorption and emission spectra for complexes **2** and **15** are shown in FIG. 4 and 5 respectively. The intense orange to red phosphorescence of the complexes in the present invention together with their stability towards sublimation means that these materials can be used as emitters or dopants in high-performance OLEDs.

[0053] Organic Light-emitting Devices

[0054] The devices using the complexes in present invention, as fabricated by Prof. S. T. Lee of City University of Hong Kong, possess the multi-layer heterostructure shown in FIG. 6.

[0055] All the organic layers including the Pt complexes described above and cathodes were vacuum-deposited onto the ITO substrate. NPB (N,N'-di-1-naphthyl-N,N'-diphenylbenzidine) and Alq₃ (q=8-hydroxyquinolyl) were used as the hole transporting and electron transporting layer, respectively. BCP (2,9-dimethyl-4,7-diphenyl-1,10phenanthroline, bathocuproine) was used to confine excitons within the luminescent zone. Magnesium silver alloy was applied as the cathode. The selected Pt complex was doped into the conductive host material CBP (4,4'-N,N'-dicarbazole-biphenyl) as phosphorescent emitter. The optimal doping levels were adjusted at 2, 4 and 6% and electroluminescence from the Pt complexes were observed.

EXAMPLES

[0056] A number of examples are listed below to further illustrate the invention

Example 1

[0057] Complex 2 was used as the emitter. Typical electroluminescent spectrum, current-voltage (I-V) and luminance-voltage (B-V) curves and luminescent efficiency-current density curve of the device with a doping level of 2% are shown in FIG. 7. Turn-on voltage: ~5 V; maximum luminance: 9600 Cd/m² at 12 V; maximum efficiency: 4.2 Cd/A at 25 mA/cm². In the electroluminescent spectrum, a peak at 430 nm besides the band at 560-630 nm is observed, indicating insufficient energy transfer between the host and the dopant.

Example 2

[0058] The performance of the device using complex 2 as emitter with a doping level of 4% are shown in FIG. 8. Turn-on voltage: ~5 V; maximum luminance: 7900 Cd/m² at

10 V; maximum efficiency: 2.4 Cd/A at 30 mA/cm². At this doping level, energy transfer between the host and the dopant is saturated, thus emission from the host is avoided.

Example 3

[0059] Complex 3 was used as the emitter. The performance of the device with a doping level of 4% are shown in FIG. 9. A bathochromic electroluminescence is observed (λ_{max} 580 nm), which is coinciding with the trend of the photoluminescence shown by these complexes in room-temperature CH_2Cl_2 solutions. Turn-on voltage: ~5 V; maximum luminance: 4000 Cd/m² at 12 V; maximum efficiency: 1.4 Cd/A at 20 mA/cm².

Example 4

[0060] Complex 16 was used as the emitter. The performance of the device with a doping level of 4% are shown in FIG. 10. The electroluminescence is red with vibronically structured emission spectrum (λ_{max} 610 nm, 660 nm). Turn-on voltage: ~5 V; maximum luminance: 3200 Cd/m² at 13 V; maximum efficiency: 1.0 Cd/A at 30 mA/cm².

[0061] Generally, the organometallic light-emitting materials as depicted in FIG. I and II in present invention are demonstrated to be novel electrophosphorescent emitters applicable to high-efficiency and -brightness orange to red light OLEDs.

[0062] While it is apparent that the embodiments of the invention herein disclosed are well suited to fulfill the objectives stated above, it will be appreciated that numerous modifications and other embodiments may be implemented by those skilled in the art, and it is intended that the appended claims cover all such modifications and embodiments that fall within the true spirit and scope of the present invention.

[0063] A number of references have been cited and the entire disclosures of which are incorporated herein by reference.

What is claimed is:

1. A light-emitting material for use as an emitter or dopant in an organic light-emitting device comprising one or more metal-acetylde groups coordinated to a metal.

2. A light-emitting material for use as an emitter or dopant in an organic light-emitting diode comprising one or more acetylde groups coordinated to platinum.

3. A light-emitting material for use as an emitter or dopant in an organic light-emitting diode comprising a tridentate ligand which is coordinated to platinum using one carbon and two nitrogen atoms.

4. A light-emitting material for use as an emitter or dopant in an organic light-emitting diode comprising a tridentate ligand which is coordinated to platinum using a diimine group selected from 2,2'-bipyridine and substituted 2,2'-bipyridines, and a deprotonated aromatic group selected from phenyl, aryl and heteroatom-containing aryl.

5. A light-emitting material for use as an emitter or dopant in an organic light-emitting diode having a chemical structure represented by either Formula I or II:

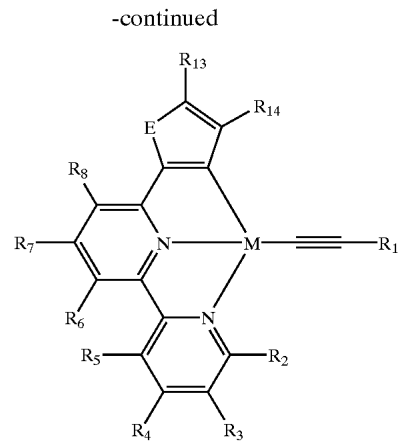
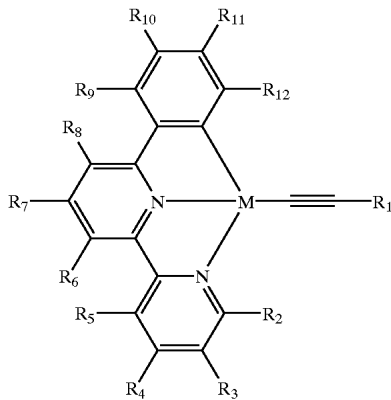

wherein E=Group 16 elements (including sulphur);
M=Group 10 metal (including platinum); R₁-R_{1,4} are each independently selected from the group consisting of hydrogen; halogen; alkyl; substituted alkyl; aryl; substituted aryl, with substituents selected from the group consisting of halogen, lower alkyl and recognized donor and acceptor groups; R₁ can also be selected from (C≡C)_nR₁₅, where (C≡C) represents a carbon-carbon triple bond (acetylide group), n is selected from 1 to 10, and R₁₅ is selected from alkyl, aryl, substituted aryl, and tri(alkyl)silyl.

6. The light-emitting material in accordance with claims 1, 2, 3, 4 or 5 which can be deposited as a thin layer by sublimation or vacuum deposition.

7. The light-emitting material in accordance with claims 1, 2, 3, 4 or 5 which can be fabricated into organic light-emitting diodes using spin-coating or other methods.

* * * * *