

# Developing a Voltage-Stability-Constrained Security Assessment System

## Part II : Structure and Function design and Technology used

L. B. Shi, H. F. Zhou, Peter T. C. Tam, N. C. Chang, J. F. Su, Z. B. Du, Y. X. Ni, Felix F. Wu\*

**Abstract**— This is the second part in a two-part paper on the development of a voltage stability constrained security assessment system (VSC-SAS). In this part, overall VSC-SAS structure and function design and technology used will be presented. The system is expected to be used in both on-line and off-line modes. In on-line mode, on-line SCADA/EMS data will be used for VSC-SAS use; while in off-line mode (usually day-ahead calculation), historical data can be used for VSC-SAS. Both results (i.e. system operation limits) can be selected to compare with real time operation conditions and supervision power system operation security margin.

**Index Terms**—Power system security; Dynamic security assessment; Voltage stability; On-line and Off-line mode.

### I. INTRODUCTION

It is known that the critical dynamic behaviours and stability issues is posing great challenges to the operation and control of interconnected power systems [1]. Considering that the interconnected power systems are complex large-scale, long-distance, high-voltage and heavily loaded transmission systems, and FACTS (Flexible ac transmission systems) devices such as TCSC (thyristor controlled series capacitor) and SVC (static var compensator) will be used in the interconnected power systems as well, which increase the system complexity, it is important to keep interconnected power systems operating in security region and monitor dynamic security margin constantly under normal operation conditions so as to ensure system operation reliability. Therefore, developing a dynamic security assessment system to analyze and simulate possible contingencies in order to classify potential harmful situations and to indicate and even operate preventive and/or corrective remedial actions is significant and necessary.

This paper presents the overall structure of a Voltage Stability Constrained Security Assessment System (VSC-SAS). The VSC-SAS scope is to provide Energy Management System (EMS) operators with a tool for voltage stability analysis to be used on-line during the normal cycle of real time operation and off-line with the purpose of study and research.

The VSC-SAS technical functions are: to calculate the operation limit without/with generation intertripping and/or load shedding, to calculate the branch circuit and corridor power limits; and its technical aims are: to monitor the on-line operating conditions of the real power systems, to reduce the

branches incidents resulting from stability problems by simulating dynamic contingencies, to provide advanced real time dynamic simulation tool for operator training.

The paper is organized as follows. Section II presents the operation functions and architecture of VSC-SAS. In Section III, the execution flow charts based on the on-line/off-line mode are discussed. The interface with EMS and the security system are described in Section IV. Section V details the preliminary results. The conclusions are summarized in Section VI.

### II. VSC-SAS OPERATION FUNCTIONS AND ARCHITECTURE

#### A. VSC-SAS Operation Functions

VSC-SAS can be inserted in existing EMS or engineered into new EMS structure. The following two modes can be activated: (i) On-line mode, (ii) Off-line mode. A brief description of each mode is in this section to follow.

(i) **On-line mode**: the EMS feeds VSC-SAS with network data and solutions. EMS server will transfer the real time file with the time-dependent format to the VSC-SAS server hourly. Once the user activates the on-line function, the real-time case file should be calculated continually until that user stops the process manually. The whole operating process is automatic.

(ii) **Off-line mode**: it is the off-line application of VSA studies and performed mainly for planning purposes. It's related to the day-ahead case files to be analysed for next day (or next two or three days).

VSA is quite mature methodology and technique. Many efforts have been done [2-4] to use it in the real power system analysis. In the VSC-SAS system, the VSAT commercial software [5] is embedded as API interface to calculate the corresponding voltage and branch circuit limits.

#### B. VSC-SAS Architecture

The VSC-SAS applications run in a distributed environment, with the Client/Server (C/S) and Browser/Server (B/S) models. This system consists of the following 7 subsystem: (i) Data acquisition: to get the real time data from SCADA/EMS; (ii) Off-line server engine: to receive the command from off-line client GUI and operate the corresponding actions; (iii) On-line server engine: to receive the command from on-line client GUI and operate the corresponding actions; (iv) Off-line client engine: to create the day-ahead case files with the purpose of planning study via GUI; (v) On-line client engine: to control the process of on-

\* The authors are with the department of Electrical and Electronic, the Univ. of Hong Kong, Hong Kong SAR (e-mail: lbshi@eee.hku.hk)

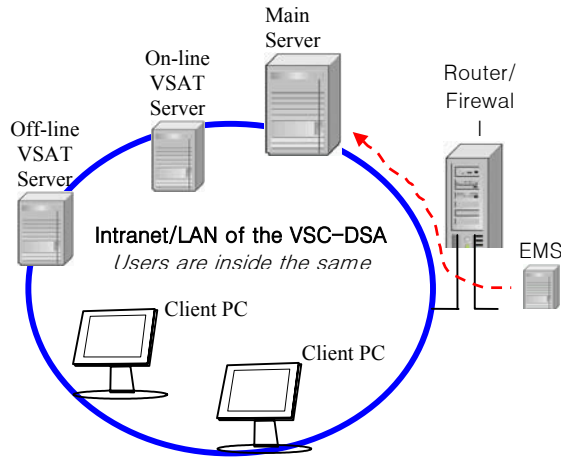

Fig. 1. Overall VSC-SAS system architecture

line mode; (vi) Off-line VSAT client engine: to implement the voltage stability analysis based on off-line mode; (vii) On-line VSAT client engine: to implement the voltage stability analysis based on on-line mode. The architecture includes a main server in which the interface with the SCADA/EMS server, database system, web server system et al., are hosted; an on-line VSAT server specially used for the calculation of voltage stability analysis based on the on-line mode; an off-line VSAT server specially used for the solutions of voltage stability analysis based on the off-line mode as mentioned above; Client PC(s) for users to send commands to the corresponding server(s) based on the C/S model and browse the visualized results using IE based on the B/S model; a LAN structure for inter-machine communications allowing easy integration also in existing EMS. The whole frame that constitutes the VSC-SAS environment is shown in Figure 1.

In the VSC-SAS, the advanced technologies are widely used in this system. In network programming aspect, server-client model, web server-browser model, and socket technology are used. VSC-SAS system can make on-line and off-line analysis on two PCs of the system in parallel with the help of process control technology. For web-server, Java, ASP, IIS and HTML etc technologies will be used. It allows information sharing of remote and multi-clients. The network technology makes VSC-SAS system very flexible and easy for maintenance and expansion. In database technology aspect, Data Access Objects (DAO), Open Database Connectivity (ODBC) and ActiveX® Data Objects (ADO) [6] are used in API (application programming interface), which provides the ability of writing applications that are independent of any particular database management. Other used technologies include programming with Visual C++, Visual Basic, SourceSafe and OOP (object-oriented programming), component technology etc.

### III. VSC-SAS SYSTEM EXECUTION FLOW CHART

Just as mentioned above, the on-line mode and off-line mode analysis can run in parallel. It should be noted that for the on-line mode, once the corresponding server engine is triggered, the whole operating process is automatic; for the off-line mode, however, users have to operate the process

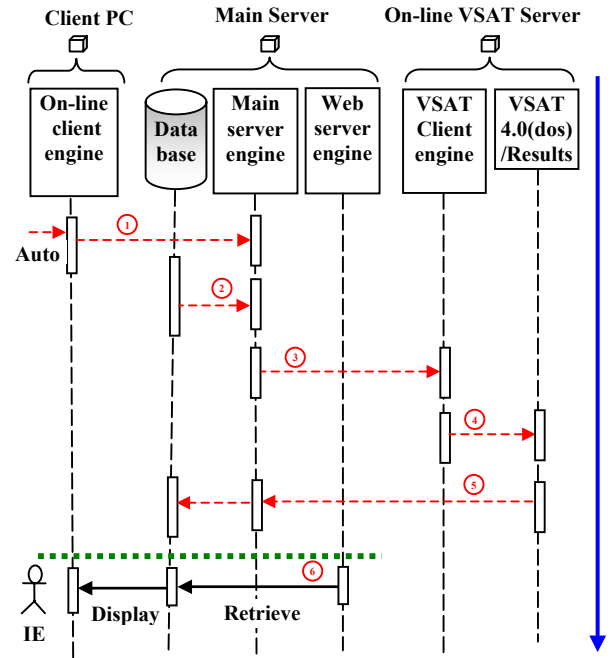

Fig. 2. Data and execution flow chart for on-line mode

manually. Furthermore, in order to check the validity and integrity of the source data, the confirmation of power flow convergence will be done in the on-line/off-line mode, respectively. The details of the on-line/off-line operating mode are described as follows.

#### A. On-line VSC-SAS Data and Execution Flow

The On-line is so called On-line, the trigger of VSC-DSA main server engine is time-dependent related to the client engine. In other words, the whole operating process is automatic. Only one real time data will be directly transferred to the on-line VSAT server with on-line calculation function every hour. Once the on-line mode is activated by user, the whole on-line calculation process is automatic. Moreover, it can be stopped by user as well. The corresponding data and execution flow chart is shown in Figure 2.

- (1) Activate VSC-SAS main server engine. Only retrieve the latest real time case file.
- (2) Retrieve the latest data information from database.
- (3) Download the latest data file to the on-line VSAT server for voltage stability analysis purpose.
- (4) Check the convergence of power flow automatically and call VSAT software to make the voltage stability analysis.
- (5) Analyze the results and record the corresponding information to the database.
- (6) Browse the results using IE.

#### B. Off-line VSC-SAS Data and Execution Flow

In this mode, a directory with specified name is created in advance. It can be termed as backup or historical folder only utilized to store all case files, uploaded by EMS control center. Once the server engine receives command sent by the client with the specified time interval flag via the manual operation, it will retrieve all matched names of the case files in the Off-

line folder and return them to the client/PC for list. When the user finished the selection of the next day 24 case files (or

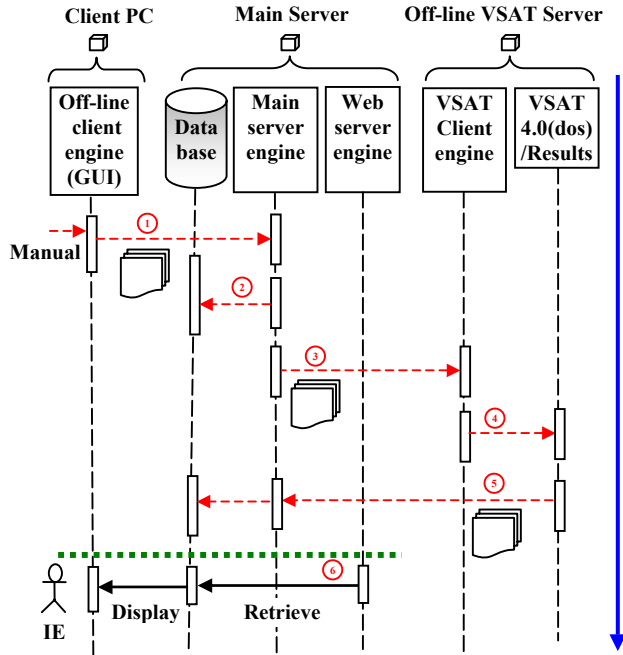

Fig. 3. Data and execution flow chart for off-line mode

more) based on the GUI in the client/PC, the user can run PSS/E and VSAT software to edit and calculate these case files. Once the power flow confirmation operation is finished, all the 24 case files (or more) are uploaded to the VSC-SAS main server and stored to another specified directory. The remaining operation process is similar as the on-line mode. The corresponding data and execution flow chart is shown in Figure 3.

- (1) Generate the planning case files based on the GUI and upload these data files to VSC-DNA main server. It should be noted that the confirmation of power flow convergence should be done before uploading.
- (2) Record the planning data information to database.
- (3) Download these planning data files to the off-line VSAT server for voltage stability analysis purpose.
- (4) Call VSAT software to make the voltage stability analysis and generate the result files.
- (5) Analyze the results and record the corresponding information to the database.
- (6) Browse the results using IE.

#### IV. INTERFACES AND SYSTEM SECURITY

Consider the possible use within actual or future Energy Management Systems, some interfaces including the real time data acquisition from EMS for the calculation and monitoring purposes, database management system and the generation of user-defined special contingencies etc. should be discussed in this section to follow. Furthermore, the system security should be also considered.

#### A. Data acquisition

In the VSC-SAS system, two kinds of source data with

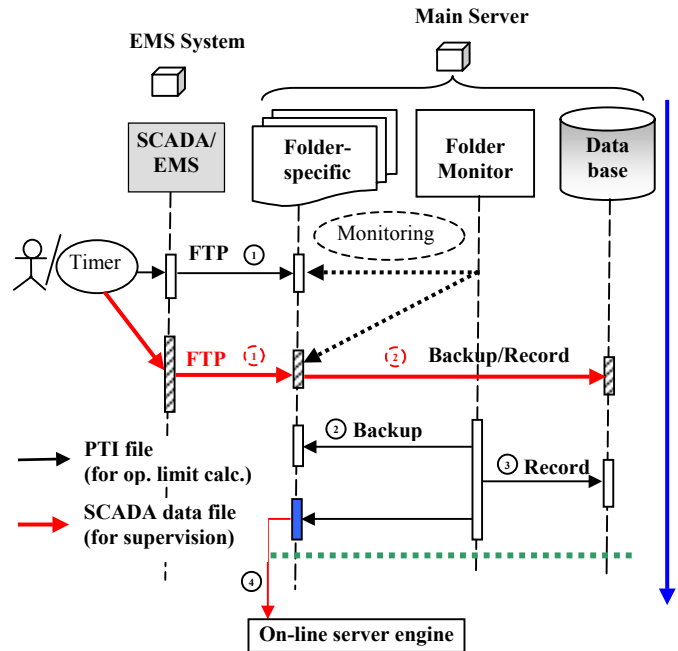

Fig. 4. Data acquisition flow chart

different implementation purposes can be available from the real SCADA/EMS system. Naturally, two different channels must be required. One is for the acquisition of real time case file(s) with the purpose of voltage stability analysis, in which the case file(s) will be downloaded to the VSAT server for the calculation of voltage stability, and another is for the acquisition of SCADA data including the voltage and branch circuit with the purpose of supervision, in which the corresponding real time data only are recorded to the database directly. The corresponding data transferring from EMS to VSC-SAS main server is based on FTP mechanism. The whole data acquisition flow chart is shown in Figure 4.

- (1) Transfer data file(s) including the case file for voltage stability analysis purpose and the real time SCADA voltage and branch circuit data from EMS to VSC-SAS main server.
- (2) Backup data file(s) and form the historical database.
- (3) Record useful information to the database.
- (4) Download the case file with the purpose of voltage

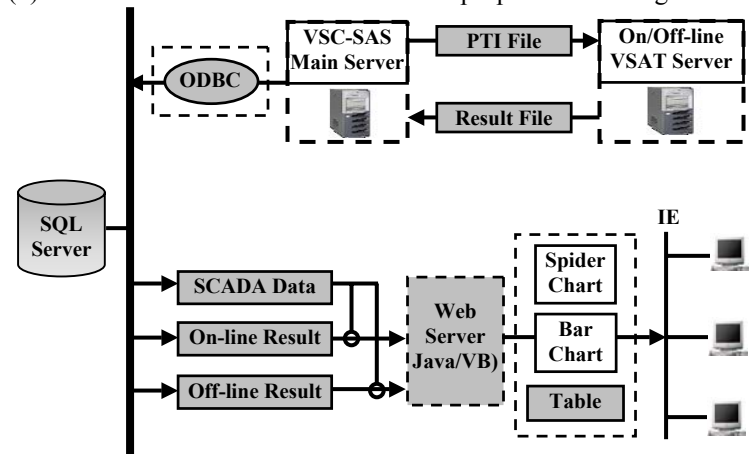

Fig. 5. Interfaces of database system with applications

stability analysis purpose to the on-line VSAT server.

### B. Database management system

A standard distributed system based on Database Management System (DBMS) [6] has three main software layers: DBMS, Applications and their Interfaces. Firstly, we select Microsoft® SQL Server™ 2000 as the DBMS platform for its high performance, reliability, quality, and ease-of-use. Secondly, for the reason of various types of applications, several different database interfaces are adopted in the VSC-DISA system. The basic frame of interfaces with VSC-DISA applications including on-line/off-line mode, web server et al., are shown in Figure 5. The main interface modules are implemented using Dynamic Link Library (DLL) technology [7].

### C. User-defined special contingencies

Considering that sometimes operators want to define some special contingencies with the purpose of studying the security of power systems under certain fault conditions. Three types of contingencies, N-1, N-2 and other special, should be defined by users in the VSC-SAS system. As users, the work of forming different kinds of special contingencies should be done in front of the client-side PCs. These user-defined special contingencies, however, must be utilized by VSAT procedure in the on-line/off-line VSAT server. Therefore, a distributed environment based user-defined special contingency formation subsystem design is required. Consider a fact that more than one user could simultaneously utilize the special contingency file which is created in advance, the latest special contingency file should be stored in the on-line/off-line VSAT server. When users run the subsystem at the client PCs, the latest special contingency file will be downloaded from on-line or off-line VSAT server. Users can create a new file or append the new defined contingencies to the old file. Once the user-defined special contingency file is formed, it will be uploaded to the on-line and off-line VSAT server, respectively. The whole execution flow chart is shown in Figure 6.

(1) Download the latest special contingency file from on-line VSAT server.

(2) Create a new file or append the new user-defined contingency to the existing file.

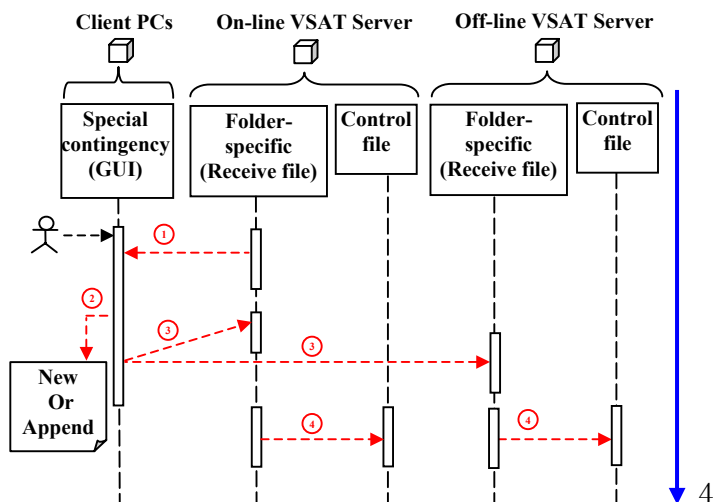

Fig. 6. Frame of user-defined special contingency formation system

(3) Upload the formed special contingency file to the on-line/off-line VSAT server.

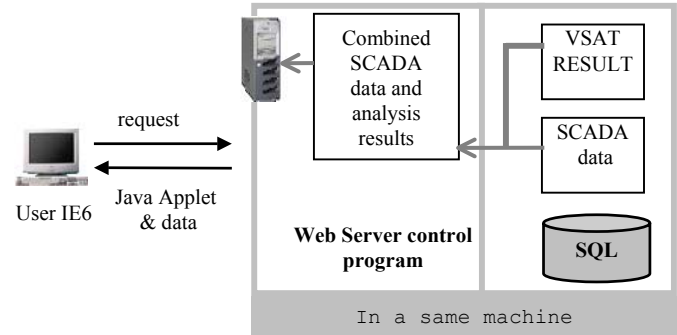

Fig. 8. Data flow of result display architecture

(4) Analyze the special contingency file and append the corresponding information to the control file used by VSAT procedure.

### D. Security system

It is known that computer security is an important issue during developing and implementing a project. In the VSC-SAS system, a security subsystem, termed as user manager, is designed to manage and maintain the security of the whole system. The system frame is shown in Figure 7. It provides flexible account and password management. Users can easily check and change their passwords, even the corresponding permissions if they own the enough rights. In such module, the following main functions can be available: (i) view account and password information; (ii) add new account; (iii) delete account; (iv) change account properties; (v) password protection control.

## V. PRELIMINARY RESULTS

This section presents some outputs of the VSC-SAS function. The results were obtained in a real power system. Just as mentioned above, the results mainly consist of limits of critical buses/branches/corridors. Furthermore, the SCADA data to be monitored should be combined with the existing results. To read the limit data, VSAT analysis results and SCADA data, a scheme is provided for user through internal network to search the database server and display the result. Figure 8 shows the data flow between the client, server and web-server program and database server. Both web server and data server are on the same computer at the time of development, but they can be separated. In order to provide the more intuitionistic and dramatic result display, there are three types of chart to display different analysis results.

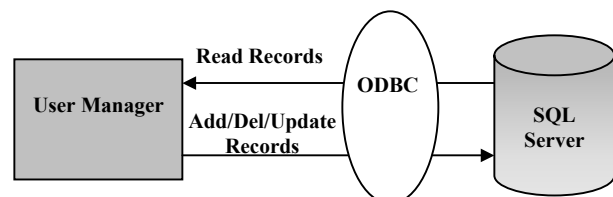

Fig. 7. Overview of User Manager Architecture



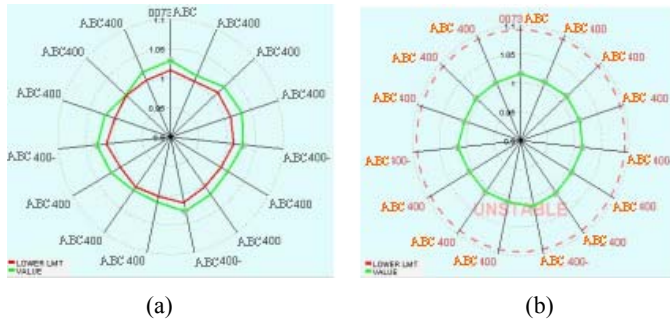

Fig. 9. Spider chart for critical and special bus voltage limits

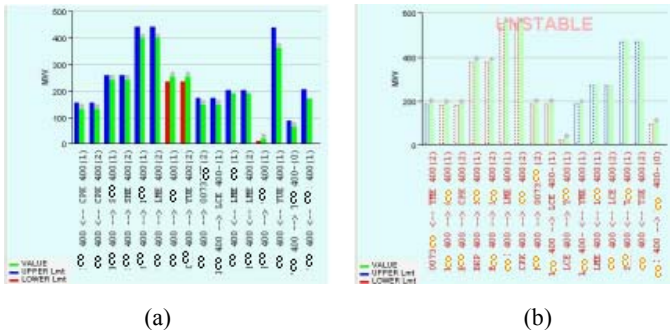

Fig. 10. Bar chart for critical and special branch power limits

(i) *Spider chart*: It is for bus display and shows voltage lower limit, real-time value (SCADA data for supervision purpose), as well as bus name, bus ID and the zone of bus. Figure 9 (a) shows the critical and special bus voltage limits under the normal condition. Figure 9 (b) shows the voltage spider chart with the ‘UNSTABLE’ situation. The lower limit is bounded by red line and voltage value by green line. If the voltage value closes to the limit and less than warning value, the bus label will change to red and axis will flash. For case which is insecure for N-1, N-2 or special contingencies, the limit will be represented by red dash line and the limit value is unknown (since the base case is already insecure and violates the operation limits). It should be noted that in some extreme case that SCADA data are not available, the corresponding non real-time (NRT) values can be found at the case file will be used and marked to indicate that it is NRT value.

(ii) *Bar chart*: It is for branch display and shows branch circuit lower or upper limit, real-time value (SCADA data for supervision purpose), as well as branch name and the zone of branch. Figure 10 (a) shows the critical and special branch power limits under the normal condition. Figure 10 (b) shows the branch bar chart in an insecure case. The green bar represents the real-time value (SCADA data) BLUE for upper limit and RED for lower limit. Similar as the voltage spider chart, in case of unstable condition, the limit will be represented by dash line and the limit value is unknown, and at the same time, ‘UNSTABLE’ is printed on the background. Furthermore, in some extreme case that SCADA data is not available, non real-time (NRT) value will be used and marked.

(iii) *Corridor chart and System margin chart*: Some corridors defined in advance are reported in bar chart. The visualization of corridor active power limits is shown in Figure 11. Similar to branch chart Green bar represents the RT (SCADA data) value by BLUE for upper limit and RED for lower limit. The

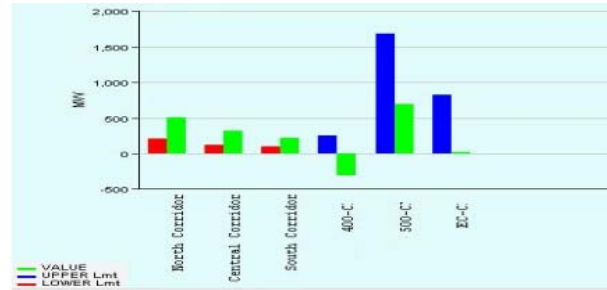

Fig. 11. Bar chart for corridor active power limits

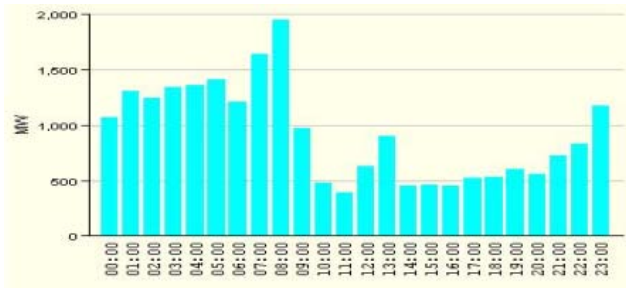

Fig. 12. Visualization of the system margin

system margin is defined as the subtraction of the P-load limit and initial P-load. The trend of system loading margin is shown in Figure 12.

In order to obtain the more details about the critical buses and branch circuits as well as the corridors, some tables are designed to assist operators get more useful information. In accordance with these tables, power system managers and operators can browse the following information: (i) the Top contingencies including the contingency name, pre-load limit-value in MW or UNSTABLE, violation type, fault information; (ii) Bus information based on the specified contingency; (iii) Branch information based on the specified contingency; (iv) Corridor information based on the specified contingency. In summary, the visualizations of buses/branches/corridors can provide more detail and important information for the power system engineers.

## VI. CONCLUSION

This paper presents a Voltage Stability Constrained Security Assessment System (VSC-SAS). The system structure, methodologies, execution flow chart, some interfaces and system security are described in detail. Some visualized results are given to provide critical information in different detail levels. This information includes the global view of system static security level in terms of the voltage magnitudes at critical buses and loadings on the monitored transmission elements. In accordance with the VSC-SAS system, some useful information can be offered to the power system operation and development.

## VI. REFERENCES

- [1] Prabha Kundur, *Power system stability and control*, McGraw-Hill, 1994.
- [2] Morison, G.K.; Gao, B.; Kundur, P., “Voltage stability analysis using static and dynamic approaches”, *IEEE Trans. on Power Systems*, Vol.8, No. 3, Aug. 1993, pp. 841-854.

- [3] Chowdhury, B.H.; Taylor, C.W., "Voltage stability analysis: V-Q power flow simulation versus dynamic simulation", *IEEE Trans .on Power Systems*, Vol.15, No. 4, Nov. 2000, pp. 1354-1359.
- [4] Lee, B.H.; Lee, K.Y., "Dynamic and static voltage stability enhancement of power systems", *IEEE Trans .on Power Systems*, Vol.8, No. 1, Feb. 1993, pp. 231-238.
- [5] <http://www.powertech.bc.ca> and <http://www.dsapowertools.com/>.
- [6] Buck Woody, *Essential SQL Server 2000*, Addison-Wesley, 2002.
- [7] John S. Lakos, *Large Scale C++ Software Design*, Addison-Wesley, 1996.

## VII. BIOGRAPHIES

**L. B. Shi** was born in 1971, China. He received Ph.D degree in 2000 from Chong Qing University. He is now a visiting scholar in University of Hong Kong. His main research interests are intelligence computing, IT application in power systems.

**H. F. Zhou** was born in 1977, China. He is now a Ph.D candidate in University of Hong Kong. His main research interests are grid computing, power markets and IT application in power systems.

**Peter T. C. Tam** is now a technical staff in EEE Dept. of University of Hong Kong. He received a master degree in computer science from Queensland University, Australia.

**N. C. Chang** was born in 1977, China. He received Ph.D degree in March 2004 from Harbin Institute of Technology, Harbin, China. Now he is a research assistant in University of Hong Kong. His main research interests are power system dynamics analysis, IT application in power systems.

**J. F. Su** was born in 1977, China. He is now a Ph.D candidate in University of Hong Kong. His main research interests are power markets.

**Z. B. Du** was born in 1977, China. He is now a Ph.D candidate in University of Hong Kong. His main research interests are power system dynamic voltage stability.

**Y. X. Ni** is now an associate professor in EEE Dept. of University of Hong Kong. Her main research interests are power system dynamics theory, power markets, FACTS, power electronics, IT application in power systems etc. She is a senior member of IEEE.

**Felix F. Wu** is now a professor in EEE Dept. of University of Hong Kong. His research interests include power markets, modern control centers, and IT applications in power systems etc. He is a fellow of IEEE.