



<b>Title</b>	<b>Recent progress in mid-range wireless power transfer</b>
<b>Author(s)</b>	<b>Lee, CK; Zhong, W; Hui, RSY</b>
<b>Citation</b>	<b>The 4th Annual IEEE Energy Conversion Congress and Exposition (ECCE 2012), Raleigh, NC., 5-20 September 2012. In Conference Proceedings, 2012, p. 3819-3824</b>
<b>Issued Date</b>	<b>2012</b>
<b>URL</b>	<b><a href="http://hdl.handle.net/10722/189863">http://hdl.handle.net/10722/189863</a></b>
<b>Rights</b>	<b>IEEE Energy Conversion Congress and Exposition (ECCE) Proceedings. Copyright © IEEE.; ©2012 IEEE. Personal use of this material is permitted. However, permission to reprint/republish this material for advertising or promotional purposes or for creating new collective works for resale or redistribution to servers or lists, or to reuse any copyrighted component of this work in other works must be obtained from the IEEE.; This work is licensed under a Creative Commons Attribution-NonCommercial-NoDerivatives 4.0 International License.</b>

# Recent Progress in Mid-Range Wireless Power Transfer

C.K. Lee & W.X. Zhong

Department of Electrical & Electronic Engineering  
The University of Hong Kong  
Hong Kong, China  
Email: ckleee@eee.hku.hk  
Email: wxzhong@eee.hku.hk

S.Y.R. Hui

Department of Electrical & Electronic Engineering  
The University of Hong Kong  
&  
Imperial College London  
Email: ronhui@eee.hku.hk & r.hui@imperial.ac.uk

**Abstract**— This is a review paper describing recent progress of mid-range applications of wireless power transfer. Starting from Tesla's principles of wireless power transfer a century ago, it outlines magneto-inductive research activities in the last decade on wireless power transfer with the transmission distance in the order of or greater than the coil dimension. It covers the basic characteristics of 2-coil systems, 4-coil systems, systems with relay resonators and the wireless domino-resonator systems.

**Keyword:** Mid-range wireless power transfer, Tesla's resonator coils

## I. INTRODUCTION

Wireless power transfer based on magnetic resonance and near-field coupling of two loop resonators was first reported by Nicola Tesla a century ago [1]. As pioneered by Tesla, wireless power transfer can be radiative or non-radiative depending on the energy transfer mechanisms. Radiative power can be emitted from an antenna and propagates through a medium (such as vacuum or air) over long distance (i.e. many times larger than the dimension of the antenna) in form of electromagnetic wave. However, due to the omni-directional nature of the radiative power emission, the energy efficiency of power transmission is very low. Non-radiative wireless power transfer relies on the near-field magnetic coupling of conductive loops and can be classified as short-range and mid-range applications.

It should be noted that wireless power transfer has been applied extensively in ac machines, which were also pioneered by Tesla [2]. Take a cage induction machine as an example, energy is transferred from the excited stator windings across the air gap to the rotor cage. Energy transfer via coupled windings is the basic principle used in electric machines.

Wireless power transfer has been an active research topic in medical applications, particularly for transcutaneous

energy systems for medical implants since 1960's [3-7]. For modern short-range applications, inductive power transfer (IPT) systems [8-12] and wireless charging systems for portable equipment such as mobile phones [13-17] have attracted much attention since 1990's and 2000's respectively. Wireless charging technology for portable electronic devices has reached commercialization stage through the launch of the "Qi" Standard by the Wireless Power Consortium [18], now comprising over 100 companies worldwide. In both IPT systems and wireless charging pads, it has been a common practice to adopt Tesla's principles of

- 1) using near-field (i.e. non-radiative) magnetic coupling (i.e. magneto-inductive effects);
- 2) resonance techniques for both transmitter and receiver circuits.

The main reasons for using the near-field magnetic coupling and resonance techniques together are to compensate the leakage inductance (i.e. taking advantage of the resonance of the magnetic field and electric field for physicists and the resonance of inductance and capacitance in the LC circuit for electrical engineers) in the power flow path and to ensure good wireless transmission energy efficiency. For IPT applications of several kilo-Watts such as charging electric vehicle, energy efficiency higher than 90% is possible. For low-power wireless charging of mobile phones (up to 5W), typical system energy efficiency exceeding 70% can be achieved. For these modern short-range domestic and industrial applications, the operating frequency is usually in the range of 20 kHz to a few Mega-Hertz. Such frequency range is chosen because the power processing circuits (which are power electronics based switched mode power converters) with this operating frequency range are commercially available and economical. This frequency range is often neglected in recent mid-range wireless power research, but is a very important factor affecting the overall system energy efficiency and costs in both short-range and mid-range wireless power transfer systems, particularly when the power level is high. Using

---

This work was supported by the Hong Kong Innovation and Technology Fund (ITF) under Project ITS/284/11.

operating frequency in excess of 10 MHz, for example, would substantially increase the costs and switching losses of the driving circuits.

With the short-range wireless power technology reaching a mature stage for domestic and industrial applications, mid-range wireless power research has been gathering momentum in the last decade. In this paper, Tesla's early work on mid-range wireless power research is briefly summarized and its implications on modern research addressed. Then recent progress on mid-range applications, starting from the use of (i) wireless power systems with 2 coil-resonators, (ii) wireless power systems with 2 coil-resonators and input and output impedance matching, (iii) wireless power systems with relay resonators (iv) wireless power domino-resonator systems are described. While these systems are still based on Tesla's wireless power transfer principles, some new advancement not previously described by Tesla is described. Comments on the practical issues essential to the engineering implementation are included so as to link theory and practice together.

## II. TESLA'S EARLY WORK ON NON-RADIATIVE MID-RANGE WIRELESS POWER TRANSFER

As the inventors of a series of technologies that have affected human society since the 20<sup>th</sup> century, Tesla's work on tuned circuits, wireless power and radio circuits has shared some common themes. According to some studies of Tesla's contribution [19], it was stated in 1943 [20] that "Tesla is entitled to either distinct priority or independent discovery of:

1. The idea of inductive coupling between the driving and the working circuits.
2. The importance of tuning both circuits, that is, the idea of an 'oscillation transformer'.
3. The idea of a capacitance loaded open secondary circuit."

Obviously, these 3 aspects of discovery have formed the founding principles for both non-radiative and radiative wireless transfer. In particular, his discovery of using both tuned circuits as an "oscillation transformer" indicates that both of the transmitter and receiver circuits are tuned to operate in the resonant mode. The "oscillation transformer" concept goes beyond pure magnetic induction principle, and more precisely, refers to the use of magnetic resonance between two magnetically coupled coil-resonators. The combined use of magnetic induction, tuned circuits and resonance operating frequency has been a common theme in his wireless power and radio investigations. Some of these features are later referred to as "non-radiative", "magneto-inductive" and "magnetic resonance" in recent mid-range wireless power research.

Despite the lack of modern equipment such as RF power amplifier or other forms of high-power power supply with tens of Mega-Hertz frequency range a century ago, Tesla's early work on non-radiative wireless power still influences

recent mid-range wireless applications. According to [2], Tesla designed his own 'high-frequency' ac generator and managed to test his apparatus at 10 kHz to 20 kHz. A diagram of one of Tesla's mid-range wireless power transfer experiment is shown in Fig.1 [21]. The setup consists of a primary (transmitter) coil and a secondary (receiver) coil. While Tesla's idea of a capacitance loaded open secondary circuit is highlighted in [19,20], it should be noted that if a high-frequency power supply that could work up to several tens of Mega-Hertz were available in Tesla's time, he could have taken advantage of the intra-winding capacitance of the receiver coil for magnetic resonance.

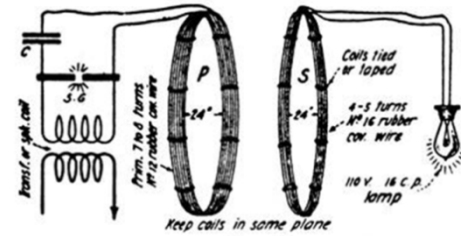

Fig.1 A diagram of one of Tesla's wireless power experiments [21]

For efficient wireless power transfer, Tesla showed that using magnetic resonance between a pair of magnetically coupled coil-resonators could achieve optimal energy transfer. This discovery has also been the focal point in recent mid-range wireless power research. The use of the resonance concept is in line with his other inventions such as tuned circuits for radios [22] and his low-frequency wireless power transfer via natural media (e.g. resonance frequency of the earth) [19].

## III. RECENT WORK ON MID-RANGE WIRELESS POWER TRANSFER

### A. Two Fundamental Concepts of Power Transfer

Before the recent work of mid-range wireless power research is addressed, it is important to differentiate (i) maximum power transfer and (ii) maximum energy efficiency power transfer.

#### (i) Maximum Power Transfer

Maximum power refers the use of the maximum power transfer theorem. Fig.2 shows the equivalent circuit of an electric system. If the source impedance is  $R_S + jX_S$  and the load impedance is  $R_L + jX_L$ , then maximum power can be delivered to the load if  $R_S = R_L$  and  $X_S = -X_L$ . Most of recent mid-range wireless power transfer research adopts this approach. However, it should be noted that the maximum energy efficiency of using this approach is 50% as illustrated in (1). For  $R_S = R_L$ ,

$$\eta = \frac{i^2 R_L}{i^2 R_S + i^2 R_L} = \frac{R_L}{R_S + R_L} = 0.5 \quad (1)$$

An example of such low energy efficiency can be seen from [23], in which the overall system energy efficiency is

only 15% while the wireless transfer efficiency between the sending and receiving resonators over about 2m is about 40%. Therefore, maximum power transfer theorem is suitable for relatively low power applications and unsuitable for high power applications.

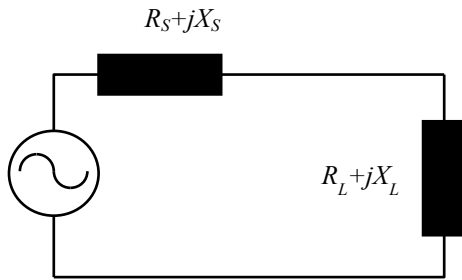

Fig.2 Equivalent circuit of an electrical system.

(ii) Maximum Energy Efficiency

Maximum energy efficiency power transfer aims at maximizing the energy efficiency in the power transfer process. For a wireless power transfer system based on resonators, a typical equivalent circuit is shown in Fig.3. Since air-core resonators are usually used, there is no magnetic core loss involved. Assuming the capacitors' equivalent series resistance is negligible and non-radiative power transfer is employed, the only type of loss is the conduction loss due to the ac resistance of the coils. The control objective is therefore to maximize the energy efficiency function (2). In principle, system energy efficiency higher than 50% is possible if this approach is adopted. Therefore, this approach is suitable for relatively high power applications.

$$\eta = \frac{i_N^2 R_L}{i_1^2 (R_S + R_1) + i_2^2 R_2 + \dots + i_N^2 (R_N + R_L)} \quad (2)$$

where  $\eta$  is energy efficiency,  $i_n$  and  $R_n$  are the current in and the ac winding resistance of the  $n^{\text{th}}$  coil respectively;  $R_L$  is the load resistance.

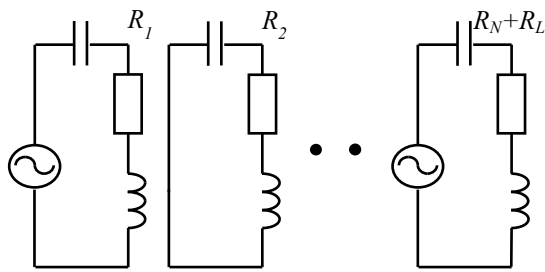

Fig.3 Equivalent circuit of a wireless power transfer based on multiple magnetically coupled resonators

B. Wireless Systems with 2 Coil-Resonators

(i) Energy efficiency with transmission distance

The analysis of mutual coupling between two resonant circuits has been well established [24,25,33]. For mid-range

applications, it has been highlighted in [25] that the magnetic coupling coefficients  $\kappa_{12}$  between two resonator coils are:

$$\kappa_{12} = \frac{1}{\left[1 + 2^{2/3} \left(d / \sqrt{r_1 r_2}\right)^2\right]^{3/2}} \quad (3)$$

if the transmission distance  $d$  is comparable with the radii of the transmitter and receiver coils  $r_1$  and  $r_2$ .

If  $d \gg r_1$  and  $d \gg r_2$ .

$$\kappa_{12} \approx \frac{1}{2 \left(d / \sqrt{r_1 r_2}\right)^3} \quad (4)$$

It has also been shown that the real-power energy efficiency is proportional to the square of the magnetic coupling coefficient, implying that the efficiency drops rapidly with transmission distance (5). This seems to be the bottleneck of a 2-coil resonator system for mid-range applications and also a possible reason for the relatively lack of mid-range applications based on Tesla's original work.

$$\eta = \frac{\kappa_{12}^2}{2} \quad (5)$$

(ii) Frequency-splitting

As mentioned previously, most of the recent mid-range wireless power research adopts the maximum power transfer approach by matching the load impedance with the source impedance. The forward voltage  $S_{21}$  parameter is often used as an indication for power transfer. A phenomenon recently observed in mid-range wireless power transfer research is called "frequency splitting". Frequency splitting occurs when the conditions for the maximum power theorem cannot be met at the resonance frequency of the resonators within the over coupled region.

For a simplified equivalent circuit as shown in Fig.4 and assuming pure resistive source and load impedance, the reflected load resistance ( $R_R$ ) is:

$$R_R = \frac{\omega_0^2 M_{12}^2}{R_L} = \frac{\omega_0^2 \kappa_{12}^2 L_1 L_2}{R_L} \quad (6)$$

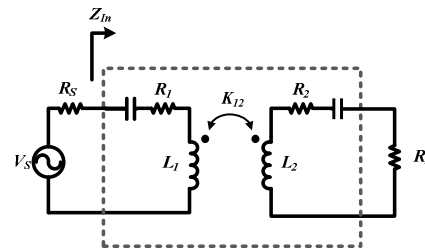

Fig.4 Equivalent circuit of a 2-coil system

Based on a 2-coil resonator system with parameters tabulated in Table I, Fig.5 shows the S-parameter  $S_{21}$  as a function of the mutual coupling coefficient and operating frequency. The mutual coupling coefficient  $\kappa_{12}$  is inversely

proportional to the transmission distance  $d$ . So a decreasing  $\kappa_{12}$  means an increasing  $d$ . It can be seen from Fig.5 that, within the over-coupled region, maximum  $S_{21}$  occurs at two frequencies in this example. Beyond the critical coupling point,  $S_{21}$  reduces exponentially with an increasing  $d$  (i.e a decreasing  $\kappa_{12}$ ).

Table I Parameters for a 2-coil wireless power transfer system

Frequency	$L_1$	$L_2$	$R_S$	$R_L$
1 MHz	100 $\mu$ H	100 $\mu$ H	50 $\Omega$	50 $\Omega$

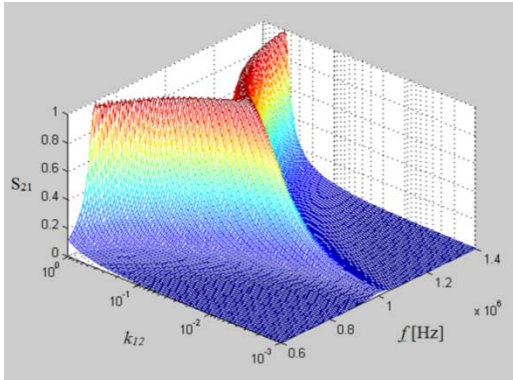

Fig.5 A plot of  $S_{21}$  as a function of mutual coupling coefficient and operating frequency for the example with parameters shown in Table I.

### C. Wireless Systems with 2 Coil-Resonators and Input and Output Impedance Matching (or The 4-coil Systems)

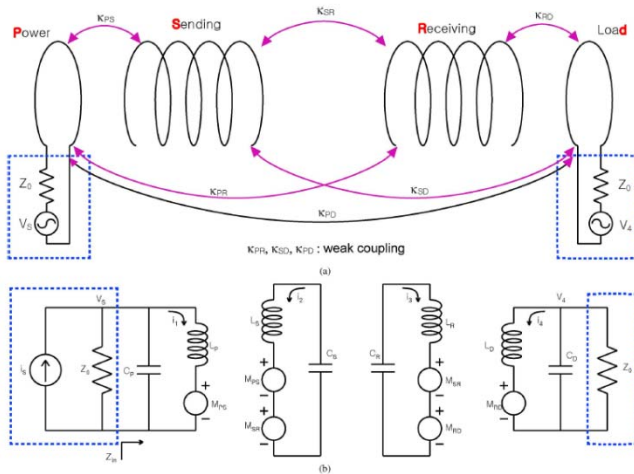

Fig.6 (a) Wireless power system with two coil-resonators, a power driving coil and a load coil, and (b) the equivalent circuits [29]

This structure actually involves 4 coils, including a sending resonator, a receiving resonator, a power driving coil and a load coil [23,26-32,34,35 ], as shown in Fig.6. While the coupled mode theory was used in [23] to explain its operation, several references [26,27,29] have transformed the analysis using electric circuit theory that is easily understood by offers more physical insights to electrical engineers. In addition, it has been pointed out [27] that the coupled mode theory does not include high order phenomena.

The use of the driving coil and the load coil offer two extra mutual coupling coefficients for impedance matching (assuming that the mutual coupling of the driving loop and the load loop is negligible). It has been pointed out in [29] that the 4-coil system provides 3 mutual coupling coefficients  $\kappa_{PS}$ ,  $\kappa_{SR}$  and  $\kappa_{RD}$  which can be utilized to maximize the transmission distance if the following condition can be met:

$$\frac{\kappa_{PS}\kappa_{RD}}{\kappa_{SR}} = 1 \quad (7)$$

If (7) can be satisfied, it has been shown in [29] that the input impedance and the reflected load impedance will be matched, therefore meeting the conditions for maximum power transfer theorem.

In order to maximize the transmission distance  $d$  for mid-range applications, the mutual coupling coefficient between the Sending resonator and the Receiving resonator should be minimized. For example, if  $\kappa_{SR}=0.01$ , by keeping  $\kappa_{PS}=0.1$  and  $\kappa_{RD}=0.1$ , the condition of (6) can be met. This method is also demonstrated in a variable tuning method in [34]. Compared with basic two-coil systems, the two extra mutual coupling coefficients in the 4-coil systems provide extra freedom for extending the transmission distance.

Frequency splitting phenomenon has been observed in the 4-coil systems [30]. The reason for such phenomenon is similar to that of the 2-coil systems. Within the over-coupled range, near-constant power transfer can be achieved. Therefore, the power receiving load can be placed within a certain range, which is an important feature for medical implants [31]. To avoid the complication of frequency splitting, an adaptive matching method based on frequency tracking has been developed [32]. In addition, it has been shown in [36] that antiparallel resonance loops can be used to eliminate the effects of frequency splitting so that constant resonance frequency can be retained.

### D. Wireless Systems with Relay Resonators

Based on a series of planar printed resonators, magneto-inductive waveguide operating at high frequency exceeding 10 MHz has been used for transmitting signal and low power [37-39]. The magneto-inductive waveguide adopts the impedance matching method (i.e obeying maximum power theorem). Therefore, the energy efficiency of the magneto-inductive waveguide cannot exceed 50%.

The use of relay resonators between the Sending coil and Receiving coil has been proposed and tested [40-43] for improving energy efficiency and extending the transmission distance. However, most of these projects still rely on high frequency operation above several Mega-Hertz and adopt the maximum power theorem. High operating frequency requires RF amplifier or sophisticated power electronic inverters as the power sources.

### E. Wireless Power Domino-Resonator Systems

Modified from the magneto-inductive waveguide concept, wireless domino-resonator systems have been investigated. The wireless domino-resonator systems are very flexible systems that allow the coil-resonators to be placed in various domino forms [44-47]. Unlike the magneto-inductive waveguide which has to operate at high frequency (typically in excess of several Mega-Hertz), the wireless domino-resonators systems work under the near-field magnetic coupling principle at sub-Mega-Hertz regime. They have been successfully tested at about 500 kHz, which is the typical switching of existing low-cost switched mode power converters. The sub-Mega-Hertz operation ensures that the switching power loss and the ac winding resistance can be kept low. In addition, new analyses on the optimization of the spacing of the resonators, the operating frequencies, the loads for achieving maximum energy efficiency have been conducted [46].

By placing adjacent resonators in shorter distances, the strong mutual coupling and thus high energy efficiency can be achieved in the wireless domino-resonator systems. Domino-resonator systems of straight-line, curved, circular and Y-shape (Figs.7a-7d) have been demonstrated [46]. One interesting feature of the domino-resonator system is that the power flow can be controlled with great flexibility. In addition, the power paths can be split or combined.

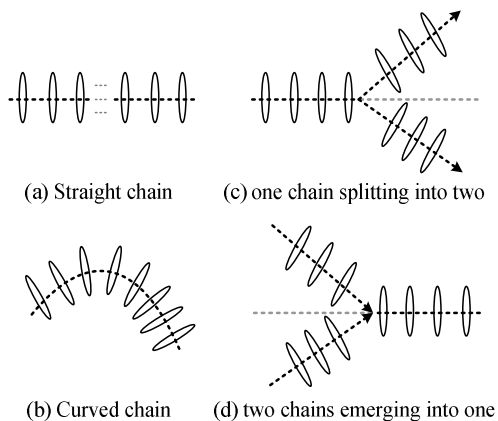

Fig.7 Examples of domino-resonator arrangements [46]

Due to the use of multiple coil-resonators, cross coupling of non-adjacent resonators cannot be ignored. It has been shown that such cross coupling effects could shift the optimal switching frequency away from the natural resonance frequency of the coil-resonators [44]. Because the domino-resonator systems are operating under the maximum energy efficiency principle, they are suitable for relatively high power applications.

Circular domino-resonator systems exhibit interesting behaviors because the power flow paths are in both clockwise and anti-clockwise directions. These behaviors can be studied with the superposition principle as reported in [45]. A photograph of a circular domino-resonator system

powering an 18W compact fluorescent lamp is included in Fig.8.

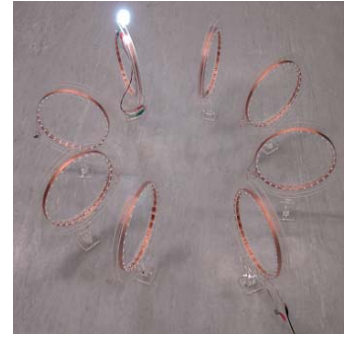

Fig.8 A photograph showing a circular domino-resonator system powering a compact fluorescent lamp [45]

## IV. CONCLUSIONS

The recent progress on mid-range wireless power transfer is reviewed in this paper. The basic principles laid down by Tesla are highlighted. The system characteristics and key features of 2-coil systems, 4-coil systems, systems with relay resonators and domino-resonator systems are described. It can be seen that these recent mid-range wireless power transfer applications still apply the basic principles proposed by Tesla a century ago. The recent use of the driving loop and load loop does provide flexibility in extending the transmission distance. Recent research on the uses of relay resonators and domino-resonator systems are covered.

## REFERENCES

- [1] N. Tesla, Apparatus for transmitting electrical energy, US patent number 1,119,732, December 1914
- [2] Robert Lomas, "The man who invented the twentieth century – Nikola Tesla – Forgotten Genius of Electricity", Publisher: Headline 1999, ISBN 0 7472 6265 9, page146
- [3] J. C. Schuder, H. E. Stephenson, and J. F. Townsend, "High level electromagnetic energy transfer through a closed chestwall," IRE Int. Conv. Rec., pt.9,vol.9,pp. 119-126, 1961.
- [4] W. H. Ko, S. P. Liang, and C.D.F. Fung, "Design of rf-powered coils for implant instruments," Med. Biol. Eng. Comput., vol. 15, pp. 634-640, 1977.
- [5] E. Hochmair, "System optimization for improved accuracy in transcutaneous signal and power transmission", IEEE Transactions on Biomedical Engineering, Vol. BME-31, No.2, Feb., 1984, pp.177-186
- [6] B. Choi, J. Nho, H. Cha, T. Ahn and S. Choi, "Design and implementation of low-profile contactless battery charger using planar printed circuit board windings as energy transfer device", IEEE Transactions on Industrial Electronics, vol. 51, no. 1, pp. 140-147, Feb. 2004.
- [7] Y. Jang and M. M. Jovanovic, "A contactless electrical energy transmission system for portable-telephone battery chargers", IEEE Transactions on Industrial Electronics, vol. 50, no. 3, pp. 520 – 527, Jun. 2003.
- [8] A.W. Green and J.T. Boys, "10 kHz inductively coupled power transfer-concept and control", Fifth International Conference on Power Electronics and Variable-Speed Drives, 1994, Page(s): 694 – 699
- [9] J.T. Boys, G.A. Covic and A.W. Green, "Stability and control of inductively coupled power transfer systems", IEE Proceedings - Electric Power Applications, Volume: 147, Issue: 1, 2000, Page(s): 37 – 43



- [10] J.T. Boys, A.P. Hu and G.A. Covic, "Critical Q analysis of a current-fed resonant converter for ICPT applications", *Electronics Letters* Volume: 36, Issue: 17, 2000, Page(s): 1440 – 1442
- [11] G.A.J. Elliott, G.A. Covic, D. Kacprzak and J.T. Boys, "A New Concept: Asymmetrical Pick-Ups for Inductively Coupled Power Transfer Monorail Systems", *IEEE Transactions on Magnetics*, Volume: 42, Issue: 10, 2006, Page(s): 3389 – 3391
- [12] M.L.G. Kissin, J.T. Boys and G.A. Covic, "Interphase Mutual Inductance in Polyphase Inductive Power Transfer Systems", *IEEE Transactions on Industrial Electronics*, Volume: 56, Issue: 7, 2009, Page(s): 2393 – 2400
- [13] B. Choi, J. Nho, H. Cha, T. Ahn and S. Choi, "Design and implementation of low-profile contactless battery charger using planar printed circuit board windings as energy transfer device", *IEEE Transactions on Industrial Electronics*, vol. 51, no. 1, pp. 140-147, Feb. 2004.
- [14] Y. Jang and M. M. Jovanovic, "A contactless electrical energy transmission system for portable-telephone battery chargers", *IEEE Transactions on Industrial Electronics*, vol. 50, no. 3, pp. 520 – 527, Jun. 2003.
- [15] C.-G. Kim, D.-H. Seo, J.-S. You, J.-H. Park and B. H. Cho, "Design of a contactless battery charger for cellular phone", *IEEE Transactions on Industrial Electronics*, vol. 48, no. 6, pp. 1238-1247, Dec. 2001. S.Y.R. Hui, W.C. Ho, "A new generation of universal contactless battery charging platform for portable Consumer Electronic equipment", *IEEE Transactions on Power Electronics*, Volume 20, Issue 3, May 2005 Page(s):620 – 627
- [16] X. Liu and S.Y.R. Hui, "Simulation Study and Experimental Verification of a Contactless Battery Charging Platform with Localized Charging Features" *IEEE Transactions on Power Electronics* Volume 22, Issue 6, Nov. 2007 Page(s):2202 – 2210
- [17] S.Y.R. Hui, "Planar Inductive Battery Charging System", US Patent 7,576,514, 2009
- [18] [online] Wireless Power Consortium Website. Available: <http://www.wirelesspowerconsortium.com>, 2012
- [19] A.S. Marincic, "Nikola Tesla and The Wireless Transmission of Energy", *IEEE Transactions on Power Apparatus and Systems*, Vol. PAS-101, No. 10, Oct. 1982, pp. 4064-4068
- [20] L.P. Wheeler, "Tesla's contribution to high frequency", *Electrical Engineering*, NY, August 1943, p.355
- [21] [online] <http://www.tfcbooks.com/articles/witricity.htm>
- [22] Tapan K. Sarkar et al, "History of Wireless: Chapter 8. Nikola Tesla and His Contributions to Radio Development", 2 Feb. 2006, Wiley
- [23] Andre Kurs et al, "Wireless Power Transfer via Strongly Coupled Magnetic Resonances", *Science* Vol. 317, 6 July 2007, pp.83-86
- [24] Eberhard Waffenschmidt and T. Staring, "Limitation of inductive power transfer for consumer applications", *European Conference on Power Electronics and Applications*, 2009. EPE '09. Page(s): 1 - 10
- [25] Jos'e Oscar Mur-Miranda et al, "Wireless Power Transfer Using Weakly Coupled Magnetostatic Resonators", *IEEE ECCE conference*, 2010, pp.4179-4186
- [26] C.J. Chen, T.H. Chu, C.L. Lin, and Z.C. Jou, "A study of loosely coupled coils for wireless power transfer", *IEEE Trans. On Circuits and Systems – II: Express Briefs*, Vol. 57, No.7, July 2010, pp.536-540
- [27] M. Kiani, and M. Ghovanloo, "The circuit theory behind coupled-mode magnetic resonance-based wireless power transmission", *IEEE Transactions on Circuits and Systems – I*, Vol. 59, No. 8, August 2012 (in press)
- [28] Y.H. Kim, S.Y. Kang, S. Cheon, M.L. Lee, J.M Lee and T. Zyung, "Optimization of wireless power transmission through resonant coupling", *International symposium on Power Electronics, Electric Drives, Automation and Motion, SPEEDAM*, 2010, pp. 1069-1073
- [29] S. Cheon, Y.H. Kim, S.Y. Kang, M. L. Lee, J.M. Lee, and T. Zyung, "Circuit-model-based analysis of a wireless energy-transfer system via coupled magnetic resonances", *IEEE Transactions on Industrial Electronics*, Vol. 58, No.7., July 2011, pp.2906-2914
- [30] A. P. Sample, D.A. Meyer and J.R. Smith, "Analysis, experimental results and range adaptation of magnetically coupled resonators for wireless power transfer", *IEEE Transactions on Industrial Electronics*, Vol. 58, No.2., Feb. 2011, pp.544-554
- [31] B.H. Waters, A. P. Sample, P. Bonde and J. R. Smith, "Power a ventricular assist device (VAD) with the free-range resonant electrical energy delivery (FREE-D) system", *Proceedings of the IEEE*, Vol. 100, No.1, Jan. 2012, pp.138-149
- [32] J. Park, Y. Tak, Y. Kim, Y. Kim, and S. Nam, "Investigation of adaptive matching methods for near-field wireless power transfer", *IEEE Transactions on Antennas and Propagation*, Vol. 59, No.5, May 2011, pp.1769-1773
- [33] T. Imura and Y. Hori, "Maximizing air gap and efficiency of magnetic resonant coupling for wireless power transfer using equivalent circuit and Neumann formula", *IEEE Transactions on Industrial Electronics*, Vol. 58, No. 10, Oct. 2011, pp. 4746-4752
- [34] T. P. Duong and J.W. Lee, "Experimental results of high-efficiency resonant coupling wireless power transfer using a variable coupling method", *IEEE Microwave and Wireless Components Letters*, Vol. 21, No. 8, Aug. 2011, pp.442-444
- [35] A. K. RamRakhyani, S. Mirabbasi and M. Chiao, "Design and optimization of resonance-based efficient wireless power delivery systems for biomedical implants", *IEEE Transactions on Biomedical Circuits and Systems*, Vol. 5, No.1 Feb. 2011, pp.48-63
- [36] W.S. Lee, W.I. Son, K.S. Oh and J.W. Yu, "Contactless energy transfer systems using antiparallel resonant loops", *IEEE Transactions on Industrial Electronics*, (in press).
- [37] R. Syms et al, "Magneto-inductive waveguide devices", *IEEE Proceedings – Microwave, Antennas Propagation*, Vol.153, No.2, April 2006, pp.111-121
- [38] R. Syms et al, "A theory of metamaterials based on periodically loaded transmission lines: Interaction between magnetoinductive and electromagnetic waves", *Journal of Applied Physics*, 97, 064909, (2005)
- [39] R. Syms et al, "Thin-film magneto-inductive cables", *Journal of Physics D: Applied Physics*, 43, (2010)
- [40] F. Zhang, S. Hackworth, W. Fu and M. Sun, "The relay effect on wireless power transfer using witricity", *IEEE Conference on Electromagnetic Field Computation*, 9-12 May, 2010, Chicago, USA.
- [41] F. Zhang, S.A. Hackworth, W. Fu, C. Li, Z. Mao, and M. Sun, "Relay effect of wireless power transfer using strongly coupled magnetic resonances.
- [42] J.W. Kim, H.C. Son, K.H. Kim and Y.J. Park, "Efficiency analysis of magnetic resonance wireless power transfer with intermediate resonant coil", *IEEE Antennas and Wireless Propagation Letters*, Vol. 10, 2011, pp. 389-392
- [43] M. Kiani, U.M. Jow and Maysam Ghovanloo, "Design and optimization of a 3-coil inductive link for efficient wireless power transmission", *IEEE Transactions on Biomedical Circuits and Systems*, Vol.5, No.6, Dec. 2011, pp. 579-591
- [44] C.K. Lee, W.X. Zhong and S.Y.R. Hui, "Effects of Magnetic Coupling of Non-adjacent Resonators on Wireless Power Domino-Resonator Systems", *IEEE Transactions on Power Electronics*, Volume: 27, Issue: 4, 2012, Page(s): 1905 - 1916
- [45] W.X. Zhong, C.K. Lee and S.Y.R. Hui, "Wireless Power Domino-Resonator Systems with Non-coaxial axes and Circular Structures", *IEEE Transactions on Power Electronics* Volume: 27, Issue: 11, 2012, Page(s): 4750 - 4762
- [46] W.X. Zhong, C.K. Lee and S.Y.R. Hui, "General Analysis on the Use of Tesla's Resonators in Domino Forms for Wireless Power Transfer", *IEEE Transactions on Industrial Electronics* [in press]
- [47] S.Y.R. Hui and W.X. Zhong, "Apparatus and Method for Wireless Power Transfer", Patent application PCT/IB2011/000050, 14 January 2011